



Workshop Manual

chassis

SUPPLEMENT

Fuel
Engine Electrical
Heater, Air conditioner
and Ventilation

3000GT '98

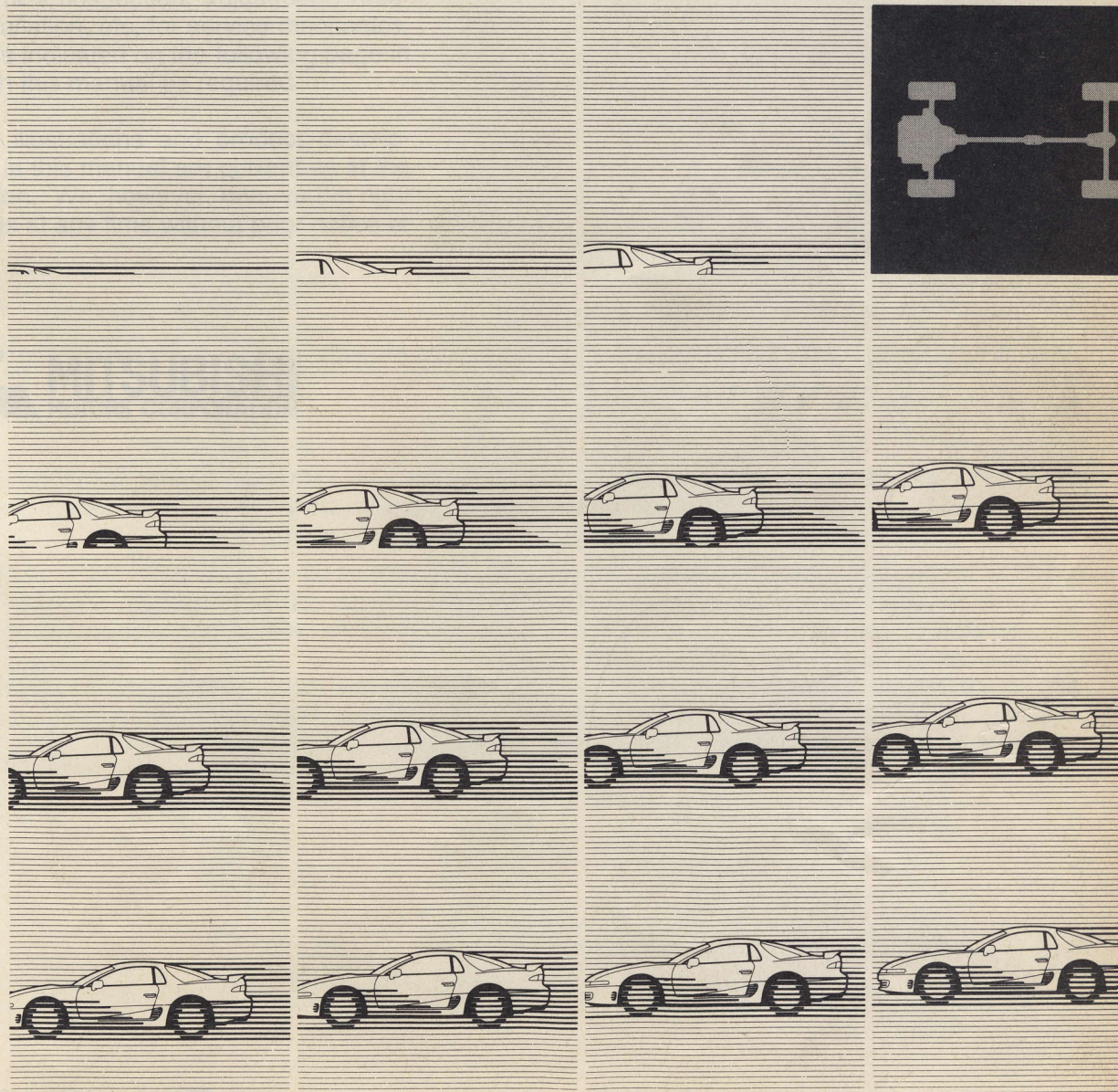

Pub. No. PWUE9119-G
Pub. No. PWUE9203-5

MITSUBISHI 3000GT

WORKSHOP MANUAL SUPPLEMENT

General	00
Fuel	13
Engine Electrical	16
Heater, Air conditioner and Ventilation	55

FOREWORD

This Workshop Manual contains procedures for removal, disassembly, inspection, adjustment, reassembly and installation, etc. for service mechanics. Use the manuals indicated on the following page in combination with this manual as required.

All information, illustrations and product descriptions contained in this manual are current as at the time of publication. We, however, reserve the right to make changes at any time without prior notice or obligation.



RELATED PUBLICATIONS

TECHNICAL INFORMATION MANUAL

WORKSHOP MANUAL

Chassis Group

<Europe>

PYUE9201

PWUE9119 (Loose-leaf edition)

PWUE9119-E (Supplement)

PWUE9119-F (Supplement)

<General Export, GCC and
Australia>

PWUE9119 (Loose-leaf edition)

PWUE9203 (Basic)

PWUE9203-1 (Supplement)

PWUE9203-2 (Supplement)

PWUE9203-3 (Supplement)

PWUE9203-4 (Supplement)

Engine Group

PWEE□□□□ (Loose-leaf edition)

ELECTRICAL WIRING

<Europe>

PHUE9201 (Loose-leaf edition)

PHUE9201-D (Supplement)

PHUE9201-E (Supplement)

PHUE9201-F (Supplement)

<General Export, GCC and
Australia>

PHUE9406 (Basic)

PHUE9406-1 (Supplement)

PHUE9406-2 (Supplement)

PARTS CATALOGUE

<Europe>

B608K408A□

<General Export, GCC>

B808K408A□

<Australia>

BFA8K408A□

WARNINGS REGARDING OF SUPPLEMENTAL RESTRAINT SYSTEM (SRS) EQUIPPED VEHICLES

WARNING!

- (1) Improper service or maintenance of any component of the SRS, or any SRS-related component, can lead to personal injury or death to service personnel (from inadvertent firing of the air bag) or to the driver (from rendering the SRS inoperative).
- (2) If it is possible that the SRS components are subjected to heat over 93°C (200°F) in baking or in drying after painting, remove the SRS components (air bag module, SRS-ECU) beforehand.
- (3) Service or maintenance of any SRS component or SRS-related component must be performed only at an authorized MITSUBISHI dealer.
- (4) MITSUBISHI dealer personnel must thoroughly review this manual, and especially its GROUP 52B – Supplemental Restraint System (SRS), before beginning any service or maintenance of any component of the SRS or any SRS-related component.

GENERAL 00

GENERAL

VEHICLE IDENTIFICATION

MODEL

VEHICLES FOR EUROPE

Model code	Engine model	Transmission model	Fuel supply system
Z16AMJGFL6	6G72 (2,972 ml)	W6MG1	MPI
Z16AMJGFR6			

VEHICLES FOR GENERAL EXPORT

Model code	Engine model	Transmission model	Fuel supply system
Z16AMNGFL	6G72 (2,972 ml)	W5MG1	MPI
Z16AMNGFR			

VEHICLES FOR GCC

Model code	Engine model	Transmission model	Fuel supply system
Z16AMNGFLW	6G72 (2,972 ml)	W5MG1	MPI

VEHICLES FOR AUSTRALIA

Model code	Engine model	Transmission model	Fuel supply system
Z16AMNGFR8	6G72 (2,972 ml)	W5MG1	MPI

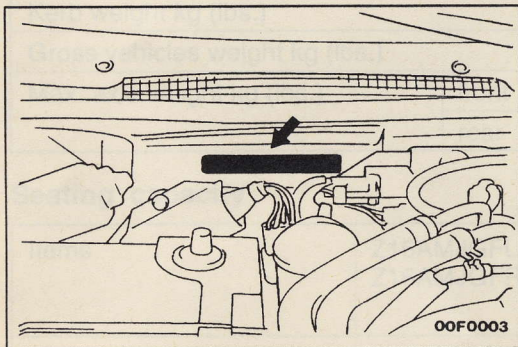

CHASSIS NUMBER

The chassis number is stamped on the toeboard inside the engine compartment.

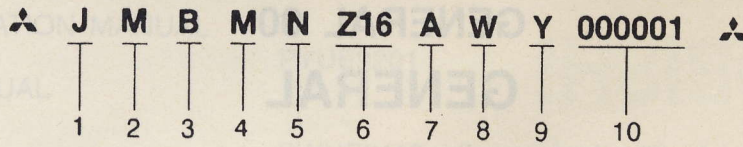

V0207AA

- | | |
|---|--|
| <p>1. Asia</p> <p>2. Japan</p> <p>3. MITSUBISHI
 A – For Europe, right hand drive
 B – For Europe, left hand drive
 F – For Australia, right hand drive
 Y – For General Export or GCC</p> <p>4. Body style
 M – 2-door hatchback</p> <p>5. Transmission type
 N – 5-speed manual transmission
 J – 6-speed manual transmission</p> | <p>6. Development order
 Z16 – 2,972 ml (Full time 4WD)</p> <p>7. Sort
 A – Passenger car</p> <p>8. Model year
 W – 1998</p> <p>9. Plant
 Y – Ohe Motor Vehicle Works</p> <p>10. Serial number</p> |
|---|--|

WARNINGS REGARDING OF SUPPLEMENTAL RESTRAINT SYSTEMS (SRS)

Improper installation, adjustment, repair, or maintenance of the SRS can lead to personal injury or death. Only trained and authorized personnel should perform SRS work. Always use proper techniques and follow the instructions in the Supplemental Restraint System (SRS) manual. Before any work is done on the SRS, the ignition must be turned off and the battery disconnected. The SRS components should be inspected for damage and replaced if necessary. The SRS components should be tested after any work is done. The SRS components should be replaced if they are damaged or if they have reached their service life. The SRS components should be replaced if they are damaged or if they have reached their service life. The SRS components should be replaced if they are damaged or if they have reached their service life.

MAJOR SPECIFICATIONS

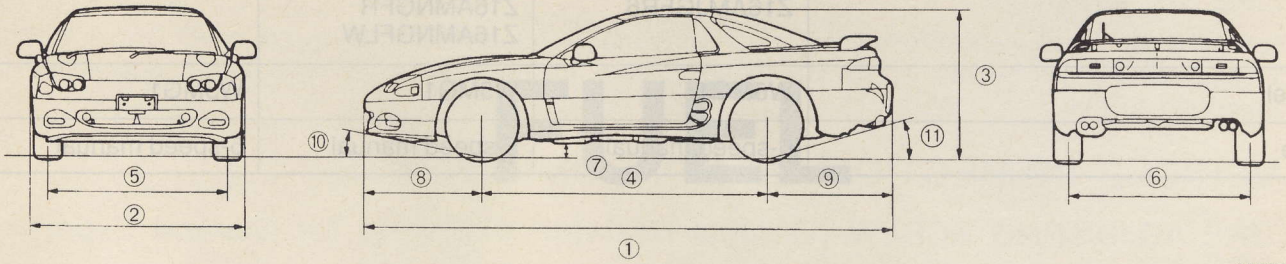

00F0064

Dimensions

Items		Z16AMJGFL6 Z16AMJGFL6	Z16AMNGFL Z16AMNGFR Z16AMNGFLW	Z16AMNGFR8
Overall length mm (in.)	①	4,570 (1799.9)	4,570 (1799.9)	4,570 (1799.9)
Overall width mm (in.)	②	1,840 (72.4)	1,840 (72.4)	1,840 (72.4)
Overall height (unladen) mm (in.)	③	1,285 (50.6)	1,285 (50.6)	1,285 (50.6)
Wheelbase mm (in.)	④	2,470 (97.2)	2,470 (97.2)	2,470 (97.2)
Track-front mm (in.)	⑤	1,560 (62.2)	1,560 (62.2)	1,560 (62.2)
Track-rear mm (in.)	⑥	1,580 (62.2)	1,580 (62.2)	1,580 (62.2)
Ground clearance (unladen) mm (in.)	⑦	140 (5.5)	140 (5.5)	140 (5.5)
Overhang-front mm (in.)	⑧	1,030 (40.6)	1,030 (40.6)	1,030 (40.6)
Overhang-rear mm (in.)	⑨	1,070 (42.1)	1,070 (42.1)	1,070 (42.1)
Angle of approach	⑩	11.2°	11.2°	11.2°
Angle of departure depress	⑪	11.7°	11.7°	11.7°

Weight

Items		Z16AMJGFL6 Z16AMJGFR6	Z16AMNGFL Z16AMNGFR Z16AMNGFLW	Z16AMNGFR8
Kerb weight kg (lbs.)		1,730 (3,858)	1,695 (3,737)	1,700 (3,748)
Gross vehicles weight kg (lbs.)		2,120 (4,674)	2,075 (4,575)	2,080 (4,586)
Max. axle weight kg (lbs.)	front	1,150 (2,535)	1,150 (2,535)	1,150 (2,535)
	rear	1,020 (2,249)	1,020 (2,249)	1,020 (2,249)

Seating capacity

Items	Z16AMJGFL6 Z16AMJGFR6	Z16AMNGFL Z16AMNGFR Z16AMNGFLW	Z16AMNGFR8
Seating capacity	4	4	4

Engine

Items	Z16AMJGFL6 Z16AMJGFR6	Z16AMNGGFL Z16AMNGFR Z16AMNGFLW	Z16AMNGFR8
Model	6G72	6G72	6G72
Total displacement mℓ	2,972	2,972	2,972

Transmission

Items	Z16AMJGFL6 Z16AMJGFR6	Z16AMNGFL Z16AMNGFR Z16AMNGFLW	Z16AMNGFR8
Model	W6MG1	W5MG1	W5MG1
Type	6-speed manual	5-speed manual	5-speed manual

Overall length (mm) (in.)	4,270 (168.0)	4,270 (168.0)	4,270 (168.0)
Overall width (mm) (in.)	1,840 (72.4)	1,840 (72.4)	1,840 (72.4)
Overall height (unladen) (mm) (in.)	1,285 (50.6)	1,285 (50.6)	1,285 (50.6)
Wheelbase (mm) (in.)	2,470 (97.2)	2,470 (97.2)	2,470 (97.2)
Track-front (mm) (in.)	1,580 (62.2)	1,580 (62.2)	1,580 (62.2)
Track-rear (mm) (in.)	1,580 (62.2)	1,580 (62.2)	1,580 (62.2)
Ground clearance (unladen) (mm) (in.)	140 (5.5)	140 (5.5)	140 (5.5)
Overhang-front (mm) (in.)	1,030 (40.8)	1,030 (40.8)	1,030 (40.8)
Overhang-rear (mm) (in.)	1,070 (42.1)	1,070 (42.1)	1,070 (42.1)
Angle of approach	11.2°	11.2°	11.2°
Angle of departure	11.7°	11.7°	11.7°

Items	Z16AMNGFR8	Z16AMNGFR Z16AMNGFLW	Z16AMJGFR8 Z16AMJGFL6
Max. axle weight (kg) (lbs)	1,020 (2,249)	1,120 (2,471)	1,120 (2,471)
Gross vehicle weight (kg) (lbs)	1,180 (2,605)	1,250 (2,756)	1,250 (2,756)
Net weight (kg) (lbs)	1,020 (2,249)	1,020 (2,249)	1,020 (2,249)

Items	Z16AMNGFR8	Z16AMNGFR Z16AMNGFLW	Z16AMJGFR8 Z16AMJGFL6
Seating capacity	4	4	4

Items	Z16AMNGFR8	Z16AMNGFR Z16AMNGFLW	Z16AMJGFR8 Z16AMJGFL6
Model	8G75	8G75	8G75
Total displacement (ml)	2,075	2,075	2,075

FUEL

CONTENTS

GENERAL	2
Outline of Change	2
ON-VEHICLE INSPECTION OF MPI COMPONENTS	2
Mixture Adjusting Screw (variable resistor) <Vehicles for General Export and GCC>	2

GENERAL

OUTLINE OF CHANGE

- The connector for the mixture adjusting screw (variable resistor) has been changed. The following maintenance service points which are different from previous vehicles have been established to correspond to this.

ON-VEHICLE INSPECTION OF MPI COMPONENTS

MIXTURE ADJUSTING SCREW (Variable Resistor) <Vehicles for General Export and GCC>

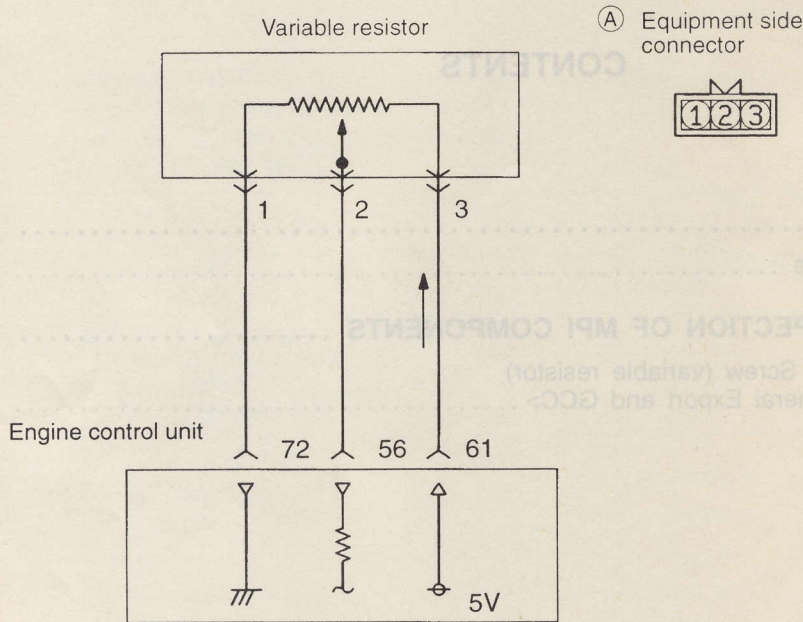

7FU2073

HARNESS INSPECTION

<p>1</p>	<p>(A) Harness side connector</p> <p style="text-align: right;">7FU2074</p>	<p>Measure the power supply voltage of the variable resistor.</p> <ul style="list-style-type: none"> • Connector: Disconnected • Ignition switch: ON <table border="1" style="margin-left: auto; margin-right: auto;"> <tr> <td style="text-align: center;">Voltage (V)</td> </tr> <tr> <td style="text-align: center;">4.8 – 5.2</td> </tr> </table>	Voltage (V)	4.8 – 5.2	<p style="font-size: 2em; text-align: center;">OK</p> <p style="font-size: 2em; text-align: center;">OK</p>	<p>→</p> <p>→</p>	<p style="text-align: center; border: 1px solid black; width: 30px; height: 30px; margin: 0 auto;">2</p> <p>Repair the harness. (A) 3 – 61)</p>
Voltage (V)							
4.8 – 5.2							

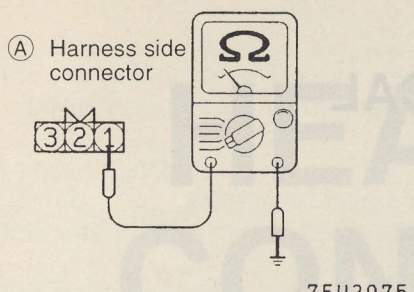
<p>2</p> 	<p>Check for continuity of the earth circuit.</p> <ul style="list-style-type: none"> • Connector: Disconnected 	<p>OK → 3</p> <p>OK → Repair the harness. (A 1 - 72)</p>
---	---	---

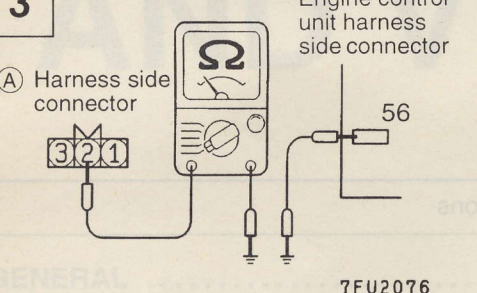
<p>3</p> 	<p>Check for an open-circuit, or a shortcircuit to earth between the engine control unit and the variable resistor.</p> <ul style="list-style-type: none"> • Variable resistor connector: Disconnected • Engine control unit connector: Disconnected 	<p>OK → STOP</p> <p>OK → Repair the harness. (A 2 - 56)</p>
---	--	--

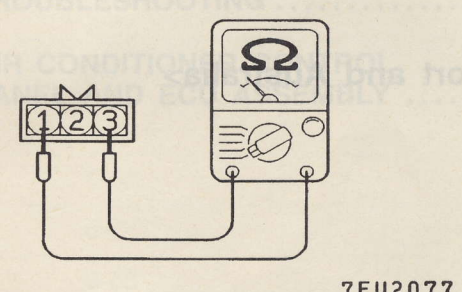

SENSOR INSPECTION

- (1) Disconnect the variable resistor connector.
- (2) Use a circuit tester to measure the resistance between terminal ① and terminal ③ of the variable resistor connector.

Standard value: 4 – 6 kΩ

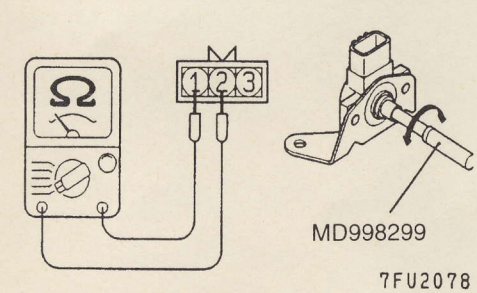

- (3) Next, connect the circuit tester between terminal ① and terminal ②.
- (4) Check if the resistance changes smoothly when the adjusting screw is rotated by the special tool (MAS driver).
- (5) Inspect the body for cracks or other damage.
- (6) If any defect is found, replace the variable resistor as an assembly.

GROUP 16 ENGINE ELECTRICAL

GENERAL

OUTLINE OF CHANGE

- The nominal output for the alternator has been changed to 110 A in vehicles for General Export and Australia. The alternator output current specifications have been changed as follows to correspond to this.

SPECIFICATIONS

SERVICE SPECIFICATIONS

ALTERNATOR <Vehicles for General Export and Australia>

Item	Specifications
Limit Output current A	77A

SERVICE ADJUSTMENT PROCEDURES

OUTPUT CURRENT TEST <Vehicles for General Export and Australia>

Inspection service points are the same as before.

Output current
Limit: 77A

HEATER, AIR CONDITIONER AND VENTILATION

CONTENTS

GENERAL	2	DAMPER CONTROL MOTOR ASSEMBLY	28
Outline of Changes	2	COMPRESSOR	29
TROUBLESHOOTING	2	CONDENSER AND CONDENSER FAN MOTOR	29
AIR CONDITIONER CONTROL PANEL AND ECU ASSEMBLY	27		

GENERAL

OUTLINE OF CHANGES

An air conditioning control panel and ECU assembly which integrates the air conditioning control panel and the ECU has been adopted. The following items have been changed to correspond to this.

- Troubleshooting
- Removal and installation service points for the air conditioning control panel and ECU assembly
- Removal and installation service points for the damper control motor assembly
- Inspection service points for operation of the thermostat and the compressor's magnetic clutch
- Inspection service points for the revolution pickup sensor
- Inspection service points for the condenser fan motor

TROUBLESHOOTING

INSPECTION CHART FOR DIAGNOSIS CODES

Code No.	Diagnosis item	Reference page
11	Interior temperature sensor system (open circuit)	55-3
12	Interior temperature sensor system (short circuit)	55-3
13	Air inlet sensor system (open circuit)	55-4
14	Air inlet sensor system (short circuit)	55-4
15	Engine coolant temperature sensor system (open circuit)	55-5
16	Engine coolant temperature sensor system (short circuit)	55-5
21	Air thermo sensor system (open circuit)	55-6
22	Air thermo sensor system (short circuit)	55-6
31	Potentiometer system of blend air damper motor assembly	55-7
32	Potentiometer system of mode selection damper motor assembly	55-8
41	Drive system of air mix damper motor assembly	55-9
42	Drive system of mode selection damper motor assembly	55-9

INSPECTION PROCEDURES FOR DIAGNOSIS CODES

Code No.11 or 12 Interior temperature sensor system	Probable cause
This diagnosis code is output if the interior temperature sensor is defective.	<ul style="list-style-type: none"> • Malfunction of connector • Malfunction of harness • Malfunction of interior temperature sensor • Malfunction of the A/C-ECU

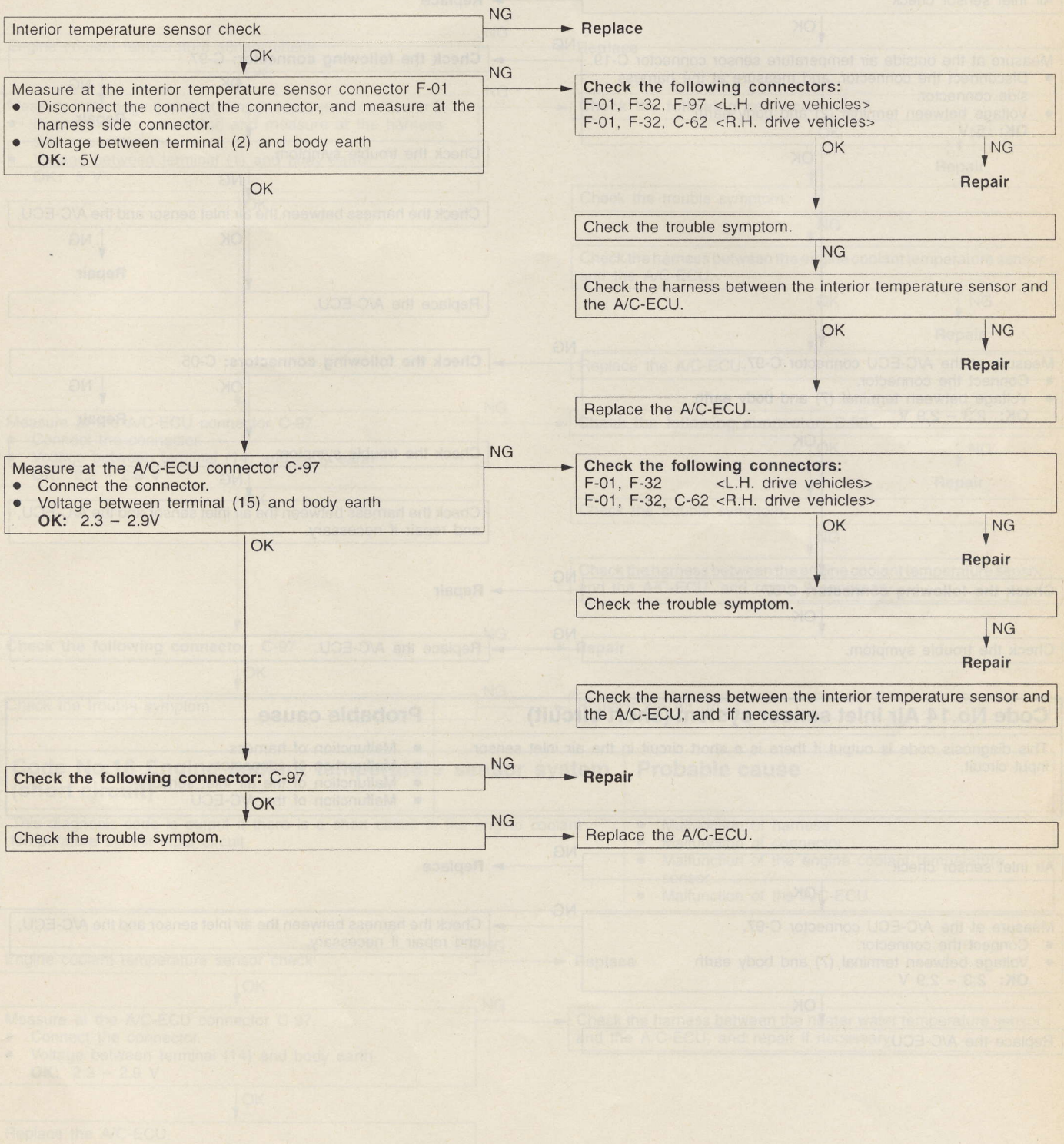

Code No.13 Air inlet sensor system (open circuit)	Probable cause
This diagnosis code is output if there is a defective connector connection, or if there is an open circuit in the harness.	<ul style="list-style-type: none"> ● Malfunction of connector ● Malfunction of harness ● Malfunction of the air inlet sensor ● Malfunction of the A/C-ECU

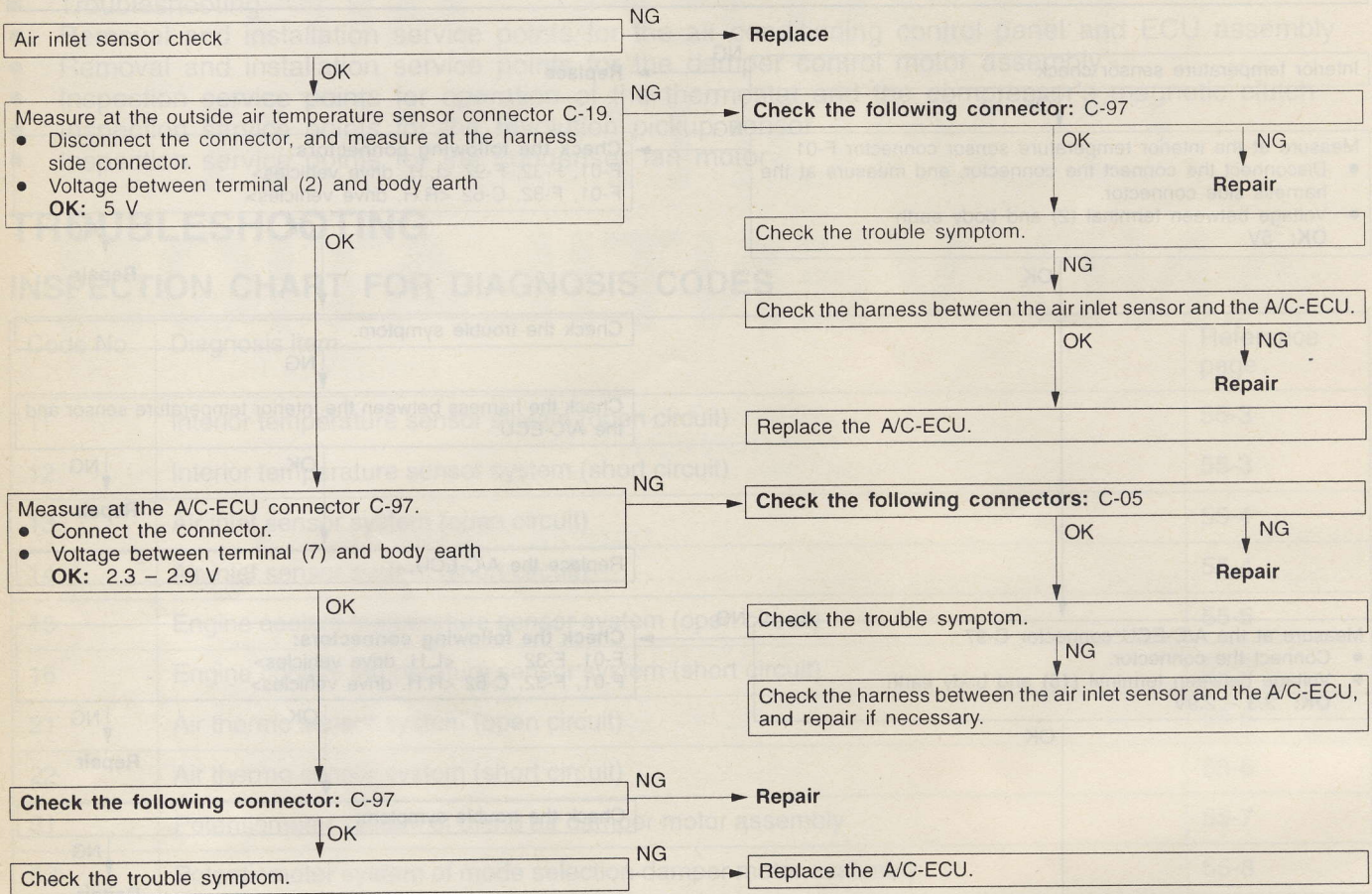

Code No.14 Air inlet sensor system (short circuit)	Probable cause
This diagnosis code is output if there is a short circuit in the air inlet sensor input circuit.	<ul style="list-style-type: none"> ● Malfunction of harness ● Malfunction of connector ● Malfunction of the air inlet sensor ● Malfunction of the A/C-ECU

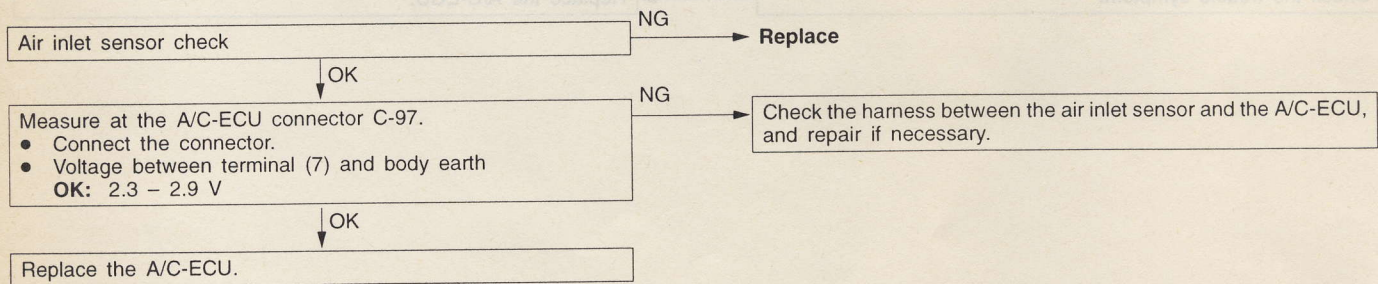

Code No.15 Engine coolant temperature sensor system (open circuit)	Probable cause
This diagnosis code is output if there is a defective connector connection, or if there is an open circuit in the harness.	<ul style="list-style-type: none"> • Malfunction of connector • Malfunction of harness • Malfunction of the engine coolant temperature sensor • Malfunction of the A/C-ECU

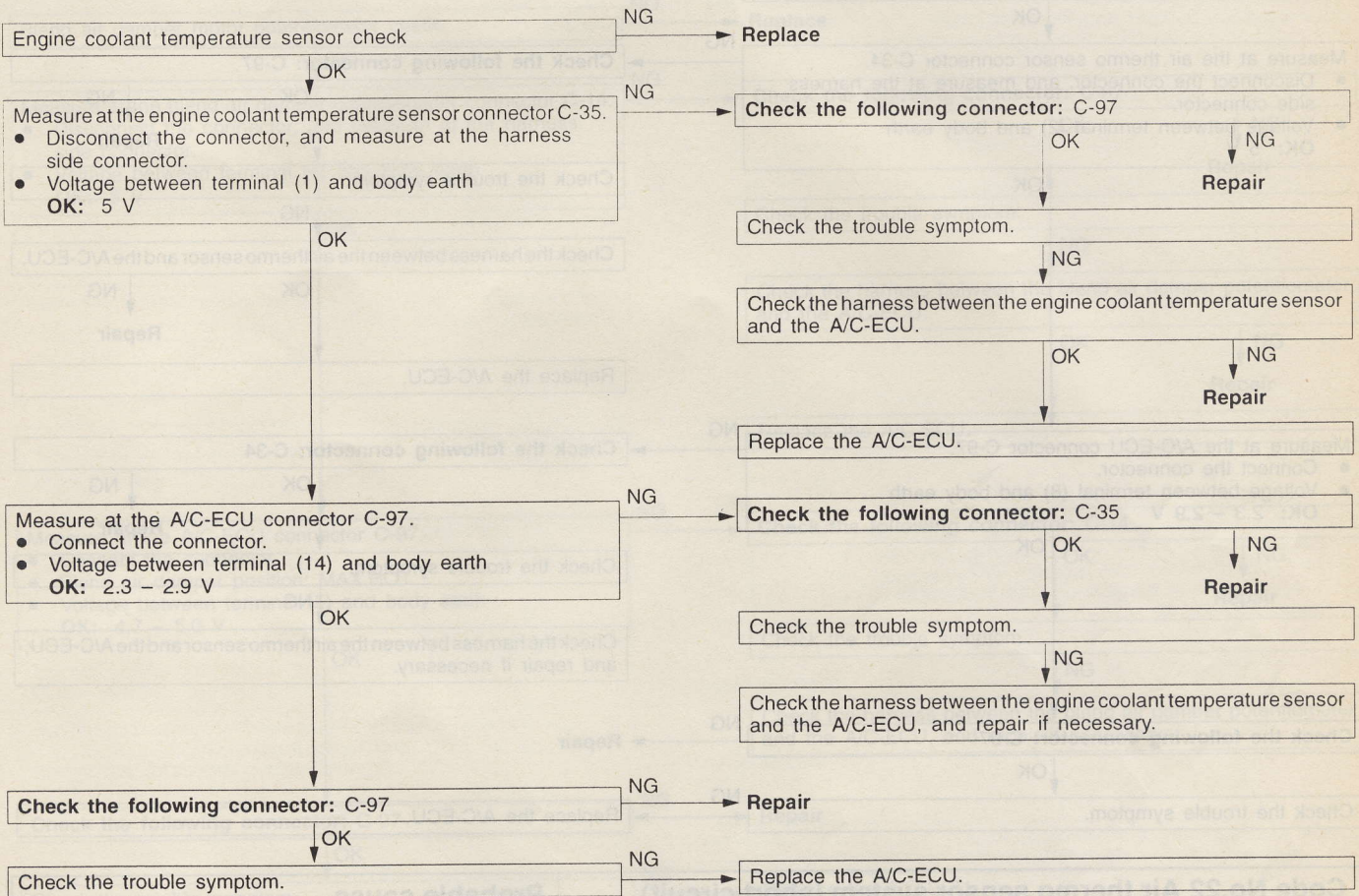

Code No.16 Engine coolant temperature sensor system (short circuit)	Probable cause
This diagnosis code is output if there is a short circuit in the engine coolant temperature sensor input circuit.	<ul style="list-style-type: none"> • Malfunction of harness • Malfunction of connector • Malfunction of the engine coolant temperature sensor • Malfunction of the A/C-ECU

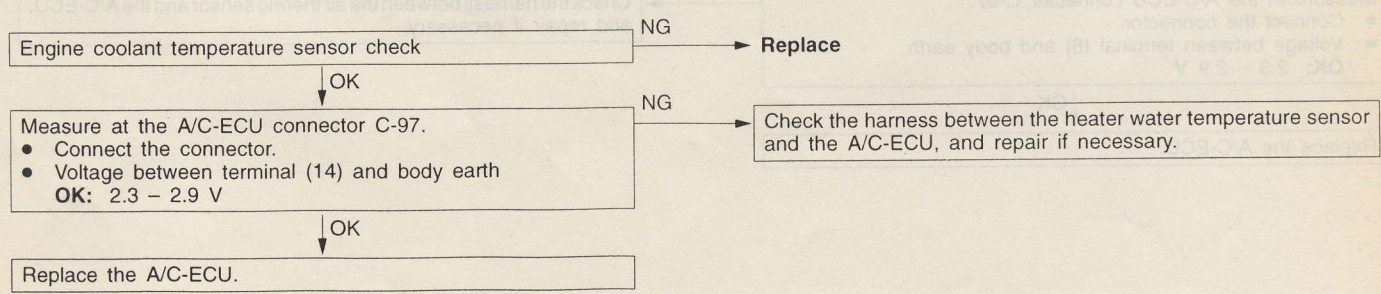

Code No.21 Air thermo sensor system (open circuit)	Probable cause
This diagnosis code is output if there is a defective connector connection, or if there is an open circuit in the harness.	<ul style="list-style-type: none"> ● Malfunction of connector ● Malfunction of harness ● Malfunction of the air thermo sensor ● Malfunction of the A/C-ECU

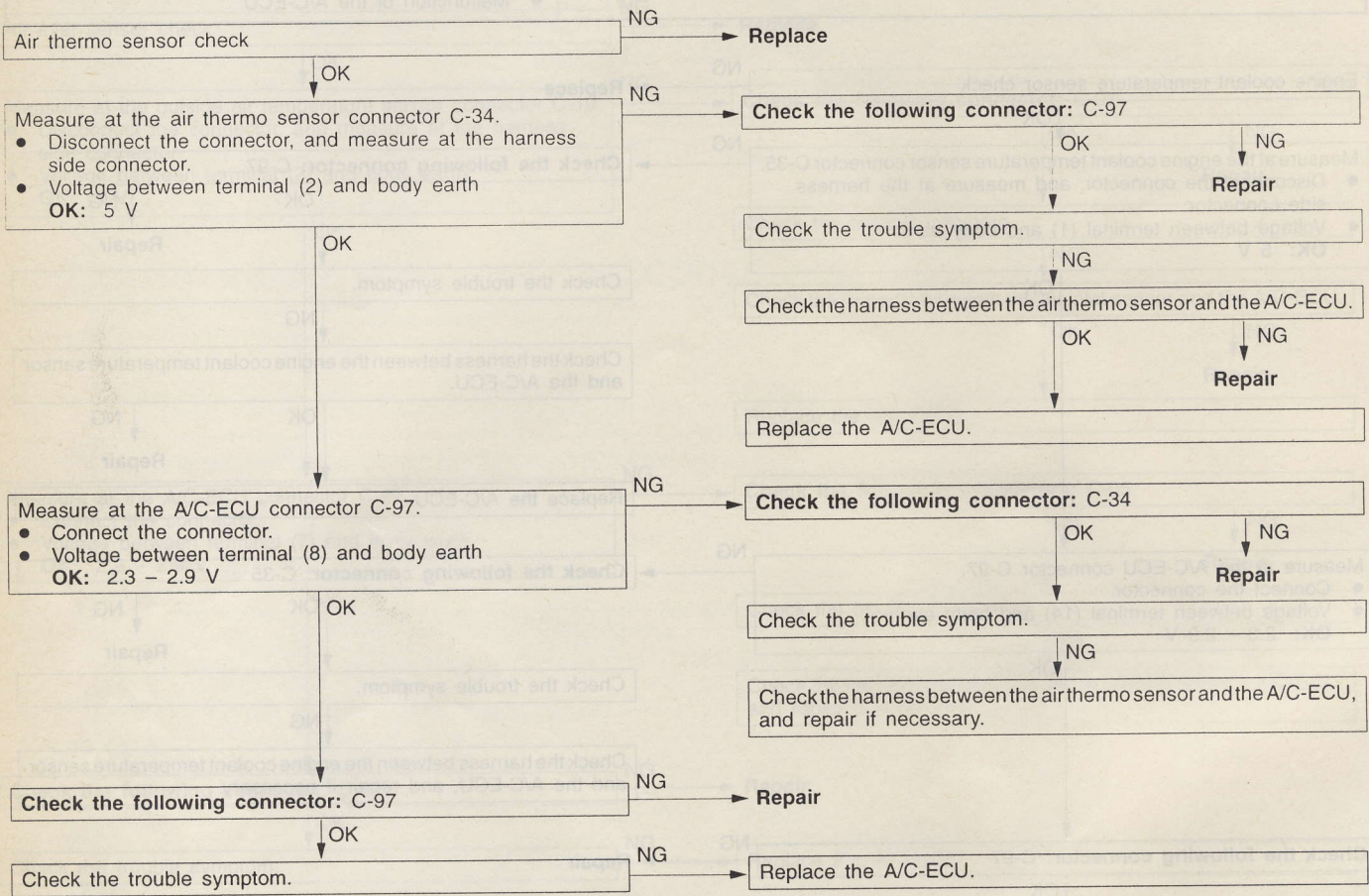

Code No.22 Air thermo sensor system (short circuit)	Probable cause
This diagnosis code is output if there is a short circuit in the air thermo sensor input circuit.	<ul style="list-style-type: none"> ● Malfunction of harness ● Malfunction of connector ● Malfunction of the air thermo sensor ● Malfunction of the A/C-ECU

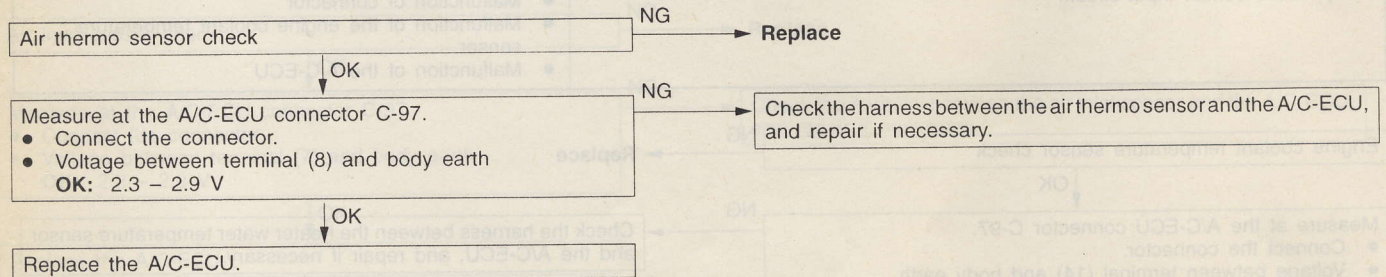

Code No.31 Potentiometer system of blend air damper motor assembly	Probable cause
This diagnosis code is output if there is an open or short circuit in the potentiometer input circuit, or if there is an open circuit in the power circuit or earth circuit.	<ul style="list-style-type: none"> • Malfunction of the blend air damper motor assembly • Malfunction of connector • Malfunction of harness • Malfunction of the A/C-ECU

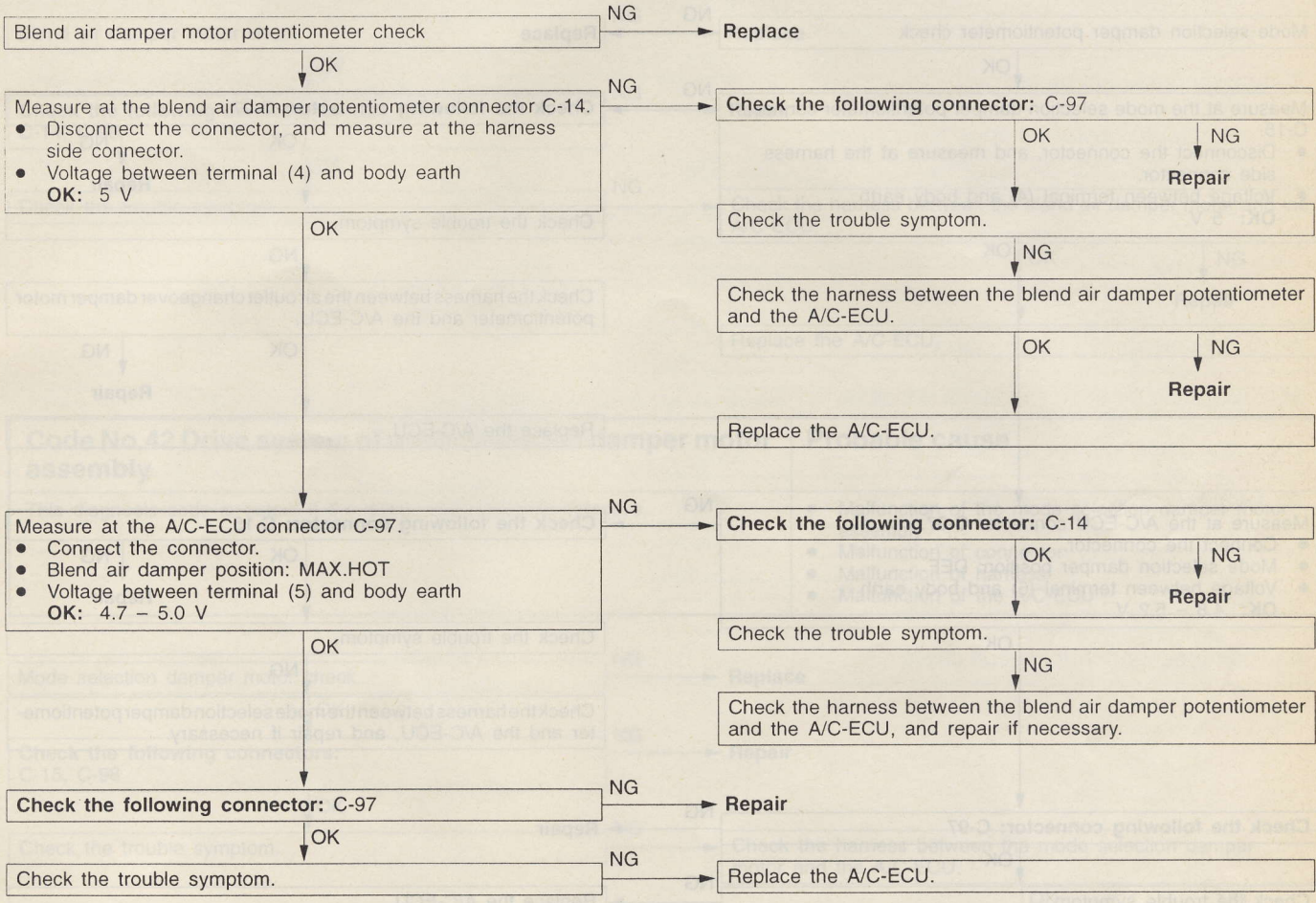

Code No.32 Potentiometer system of mode selection damper motor assembly	Probable cause
This diagnosis code is output if there is an open or short circuit in the potentiometer input circuit, or if there is an open circuit in the power circuit or earth circuit.	<ul style="list-style-type: none"> • Malfunction of the mode selection damper motor assembly • Malfunction of connector • Malfunction of the A/C-ECU • Malfunction of harness

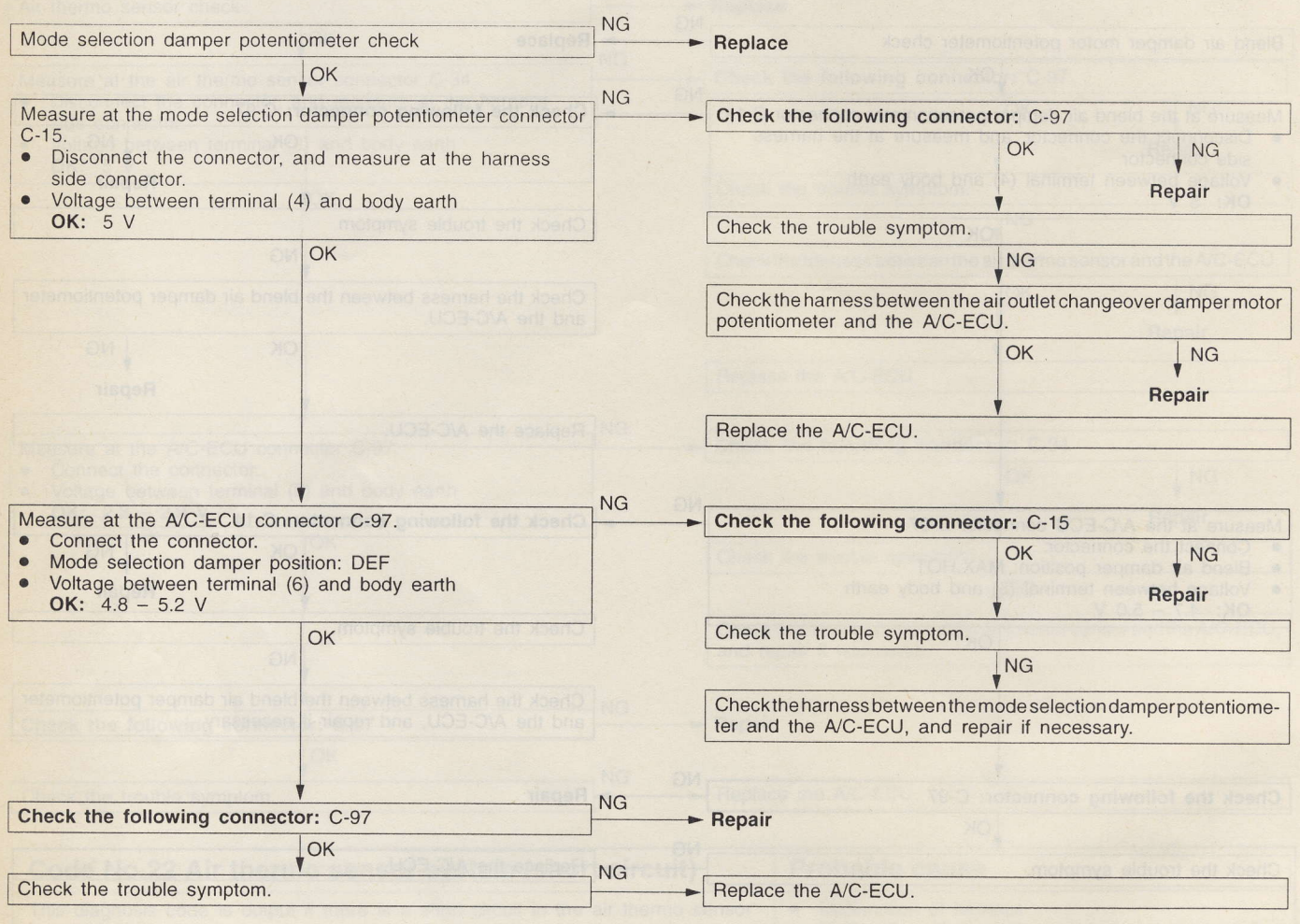

Code No.41 Drive system of blend air damper motor assembly	Probable cause
This diagnosis code is output if the motor drive circuit is defective.	<ul style="list-style-type: none"> ● Malfunction of the blend air damper motor assembly ● Malfunction of connector ● Malfunction of harness ● Malfunction of the A/C-ECU

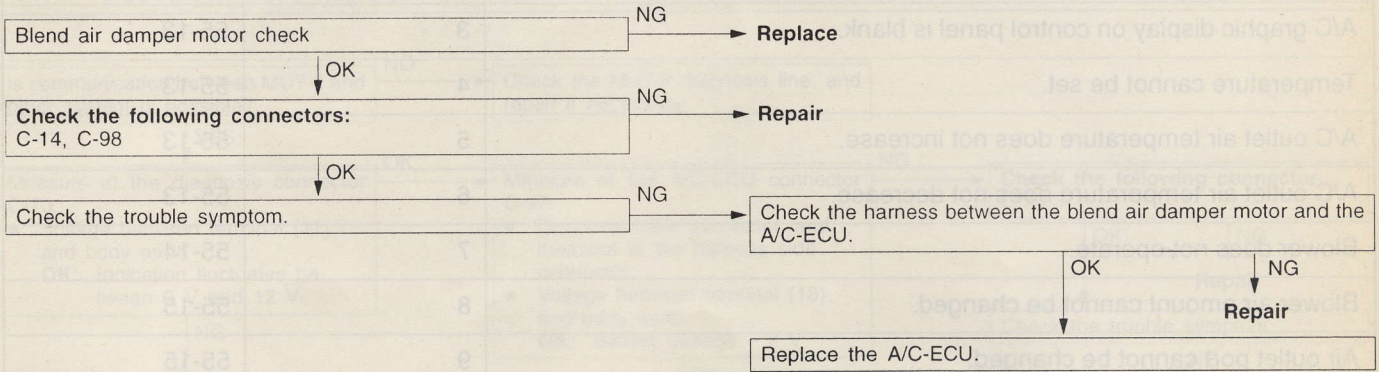

Code No.42 Drive system of mode selection damper motor assembly	Probable cause
This diagnosis code is output if the motor drive circuit is defective.	<ul style="list-style-type: none"> ● Malfunction of the mode selection damper motor assembly ● Malfunction of connector ● Malfunction of harness ● Malfunction of the A/C-ECU

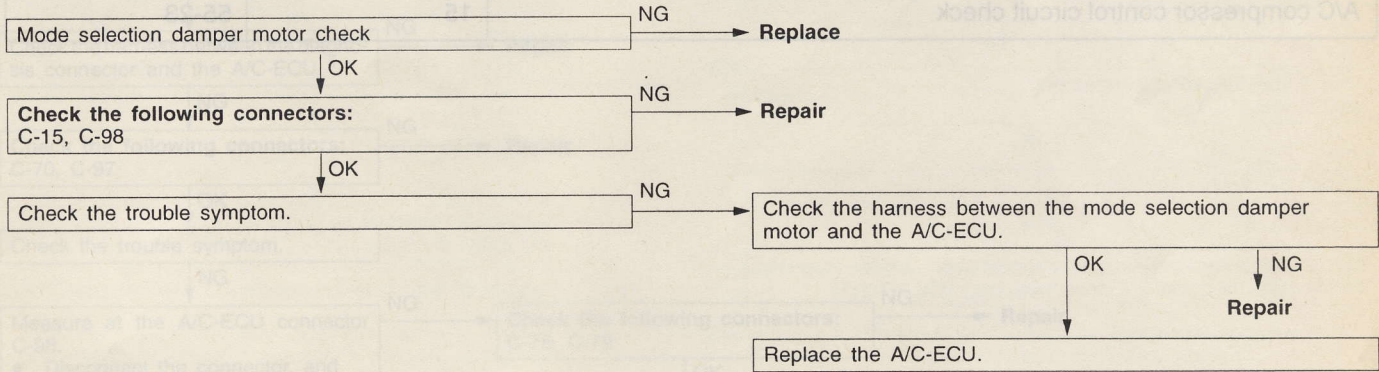

INSPECTION CHART FOR TROUBLE SYMPTOMS

Trouble symptom	Inspection procedure No.	Reference page
Communication with the MUT-II is not possible.	1	55-11
Air conditioner does not operate.	2	55-12
A/C graphic display on control panel is blank.	3	55-13
Temperature cannot be set.	4	55-13
A/C outlet air temperature does not increase.	5	55-13
A/C outlet air temperature does not decrease.	6	55-13
Blower does not operate.	7	55-14
Blower air amount cannot be changed.	8	55-15
Air outlet port cannot be changed.	9	55-15
Inside/outside air selection is not possible.	10	55-16
Defroster function does not operate.	11	55-17
Radiator fan does not operate.	12	55-18
Condenser fan does not operate.	13	55-20
A/C-ECU power supply circuit check	14	55-22
A/C compressor control circuit check	15	55-23

INSPECTION PROCEDURE FOR TROUBLE SYMPTOMS

Inspection procedure 1

Communication with the MUT-II is not possible.	Probable cause
If communication with all other systems is not possible, there is a high possibility that there is a malfunction of the diagnosis line. If communication with only the A/C is not possible, the cause is probably a malfunction of the diagnosis line or of the A/C-ECU power supply system (earth).	<ul style="list-style-type: none"> • Malfunction of connector or harness • Malfunction of A/C-ECU

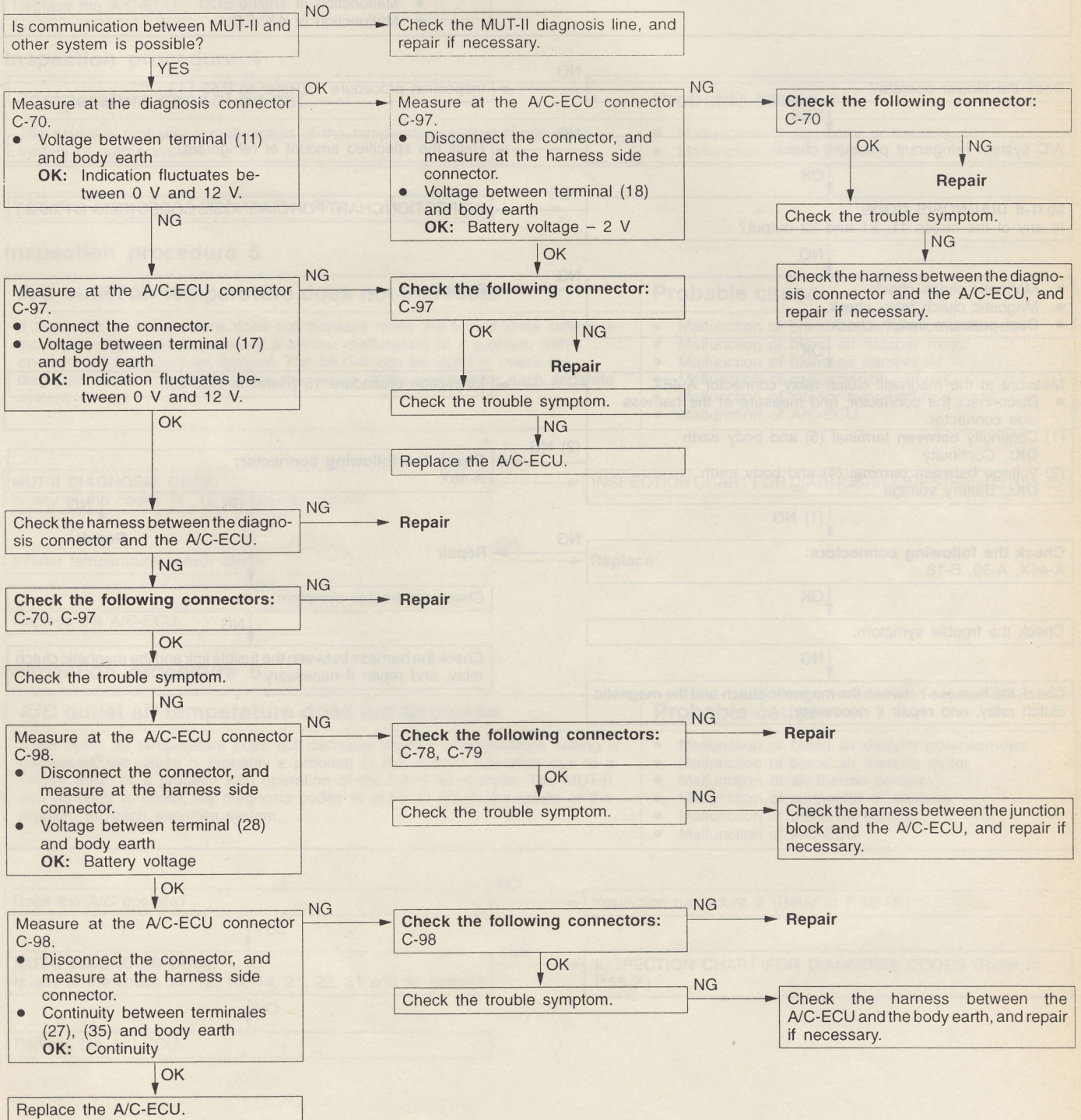

Inspection procedure 2

Air conditioner does not operate.	Probable cause
If the A/C does not operate when the A/C switch is on and the temperature setting is at 17°C, the cause is probably insufficient refrigerant, or a malfunction of the blower or of the magnet clutch power supply.	<ul style="list-style-type: none"> • Malfunction of blower • Insufficient refrigerant • Malfunction of magnetic clutch • Malfunction of air thermo sensor • Malfunction of magnetic clutch relay • Malfunction of refrigerant temperature switch • Malfunction of dual pressure switch • Malfunction of connector or harness • Malfunction of engine-ECU • Malfunction of A/C-ECU

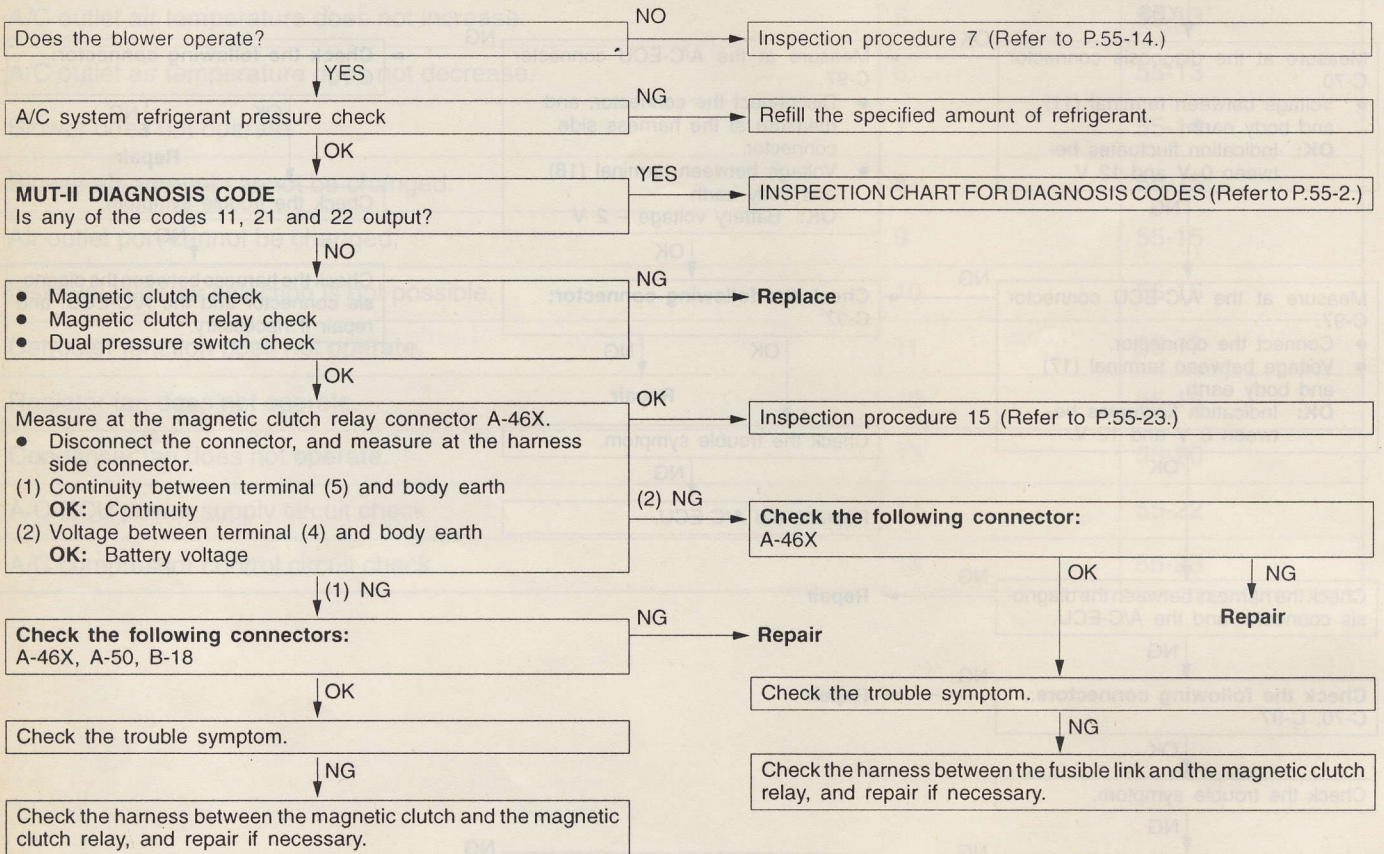

Inspection procedure 3

A/C graphic display on control panel is blank.	Probable cause
The cause is probably a malfunction of the A/C-ECU power supply system (earth).	<ul style="list-style-type: none"> • Malfunction of connector or harness • Malfunction of A/C-ECU

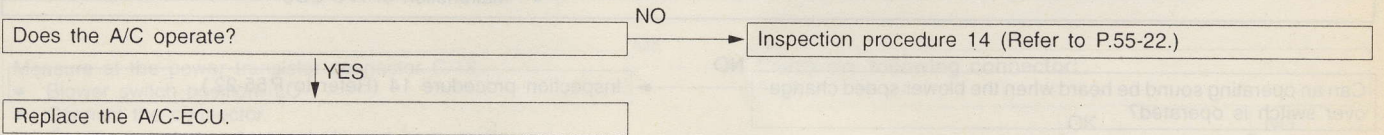

Inspection procedure 4

Temperature cannot be set.	Probable cause
The cause is probably a malfunction of the temperature setting signal input system or output system.	<ul style="list-style-type: none"> • Malfunction of connector or harness • Malfunction of A/C-ECU

Inspection procedure 14 (Refer to P.55-22.)

Inspection procedure 5

A/C outlet air temperature does not increase.	Probable cause
If the outlet air temperature does not increase when the temperature setting is increased, the cause is probably a sensor malfunction or a problem with operation of the blend air damper. The MUT-II can be used to check the diagnosis codes in order to check the cause of the problem for each separate system.	<ul style="list-style-type: none"> • Malfunction of blend air damper potentiometer • Malfunction of blend air damper motor • Malfunction of blend air damper • Malfunction of connector or harness • Malfunction of interior temperature sensor • Malfunction of A/C-ECU

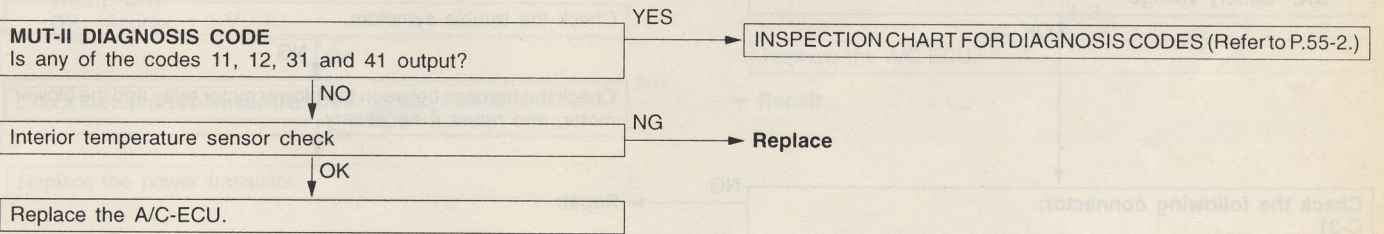

Inspection procedure 6

A/C outlet air temperature does not decrease.	Probable cause
If the outlet air temperature does not decrease when the temperature setting is decreased, the cause is probably a problem in A/C system operation due to a sensor error, or a problem with operation of the blend air damper. The MUT-II can be used to check the diagnosis codes in order to check the cause of the problem for each separate system.	<ul style="list-style-type: none"> • Malfunction of blend air damper potentiometer • Malfunction of blend air damper motor • Malfunction of air thermo sensor • Malfunction of connector or harness • Malfunction of blend air damper • Malfunction of A/C-ECU

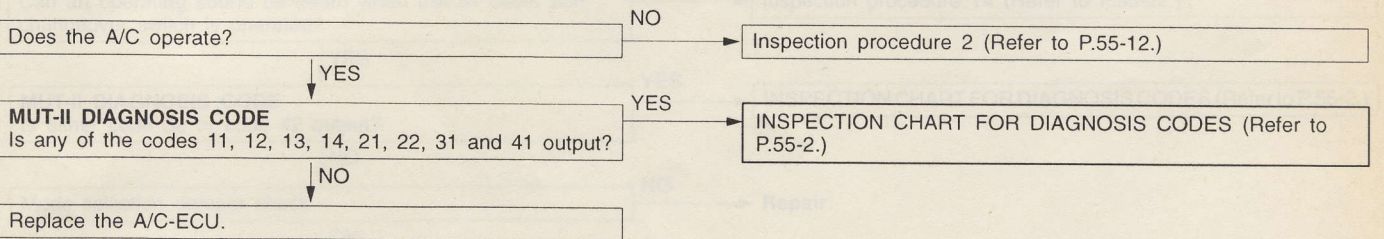

Inspection procedure 7

Blower does not operate.	Probable cause
If no air comes out of the blower even though the blower switch is on, the cause is probably a malfunction of the blower motor relay circuit.	<ul style="list-style-type: none"> • Malfunction of blower motor relay • Malfunction of blower motor • Malfunction of connector or harness • Malfunction of A/C-ECU

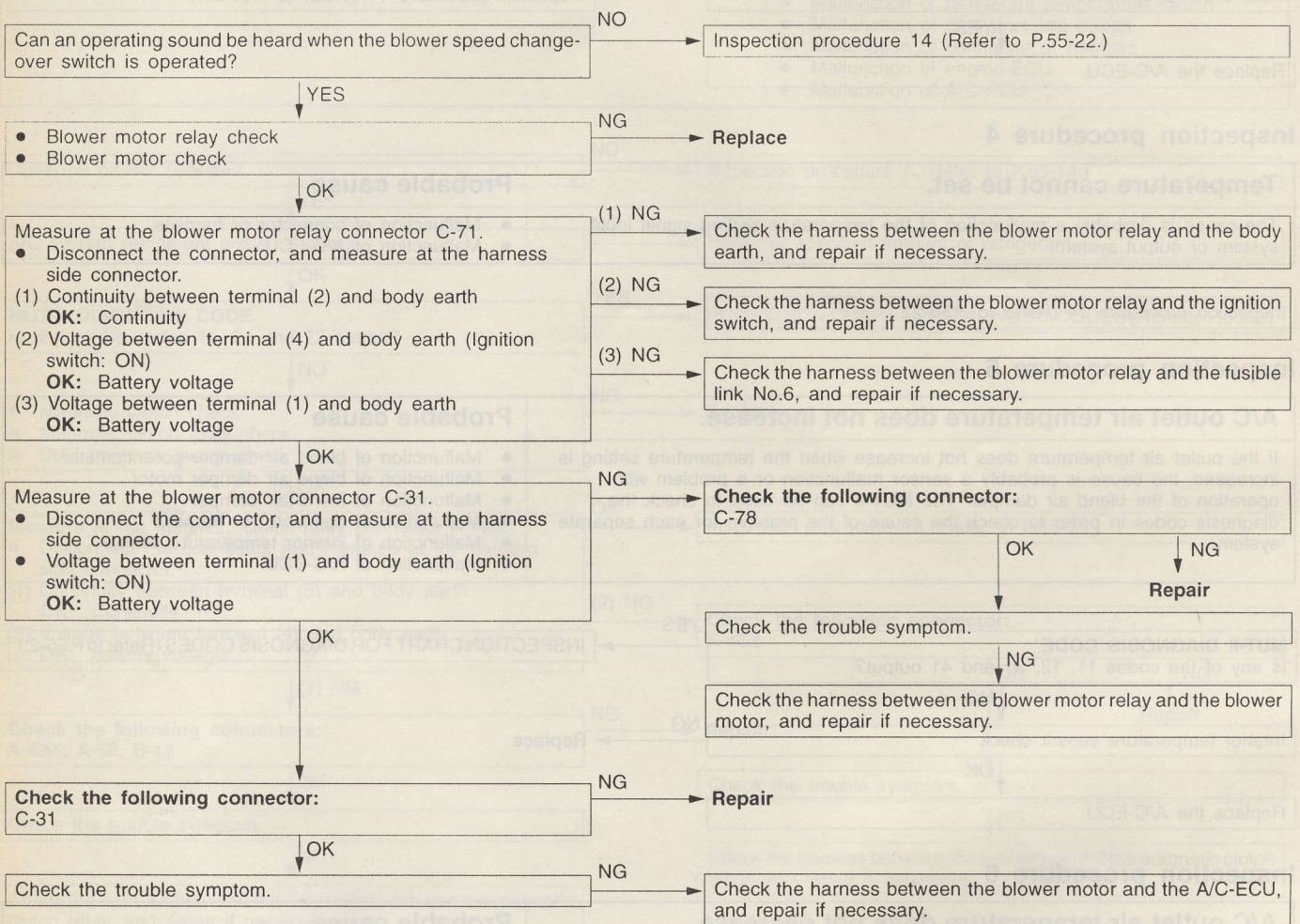

Inspection procedure 8

Blower air amount cannot be changed.	Probable cause
If the blower does not operate in any mode other than HI setting, the cause is probably a malfunction of the power transistor system.	<ul style="list-style-type: none"> ● Malfunction of power transistor ● Malfunction of connector or harness ● Malfunction of A/C-ECU

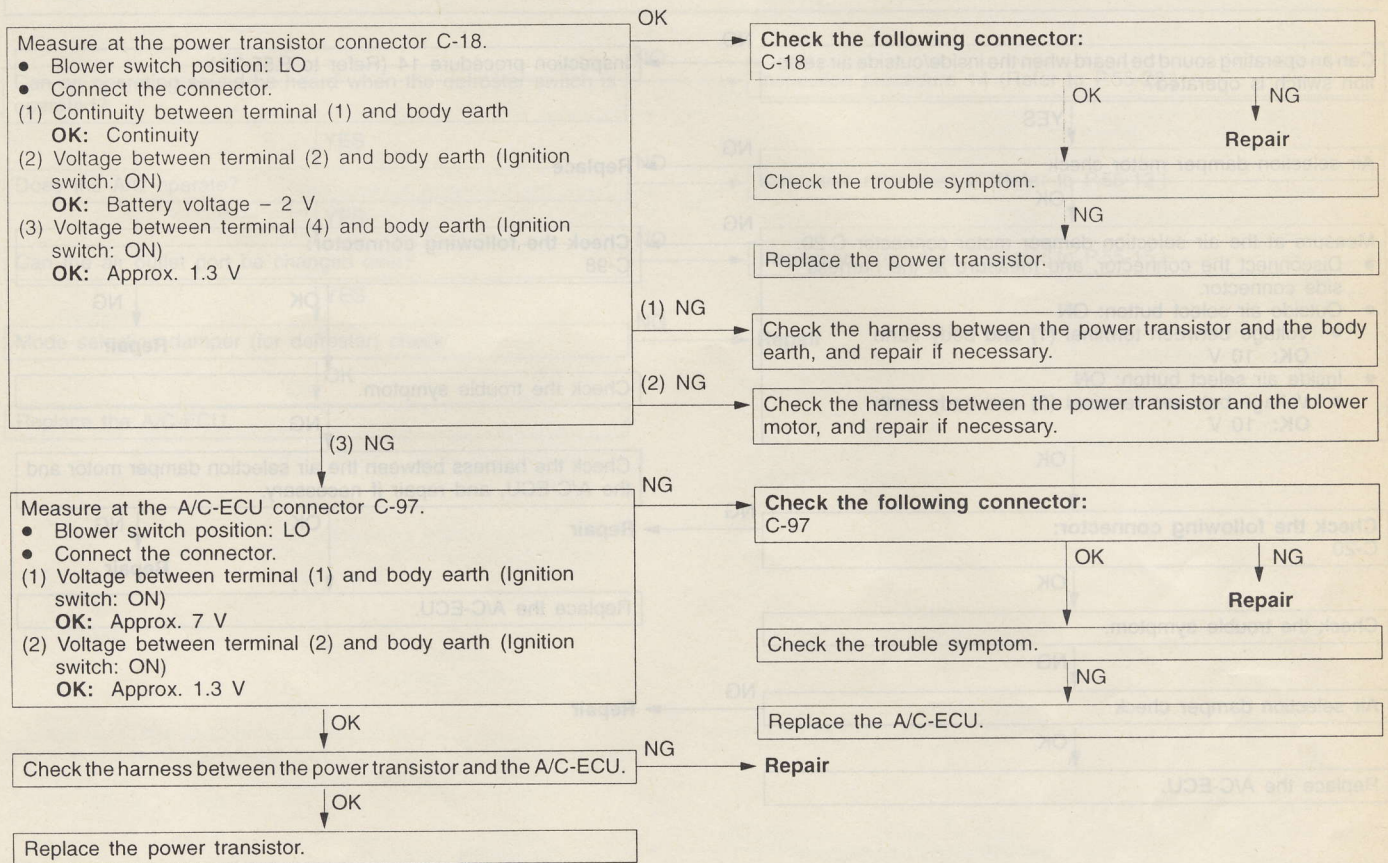

Inspection procedure 9

Air outlet port cannot be changed.	Probable cause
The cause is probably a malfunction of the air outlet port changeover signal input system or output system. The MUT-II can be used to check the diagnosis codes in order to check the cause of the problem for each separate system.	<ul style="list-style-type: none"> ● Malfunction of mode selection damper potentiometer ● Malfunction of mode selection damper motor ● Malfunction of mode selection damper ● Malfunction of connector or harness ● Malfunction of A/C-ECU

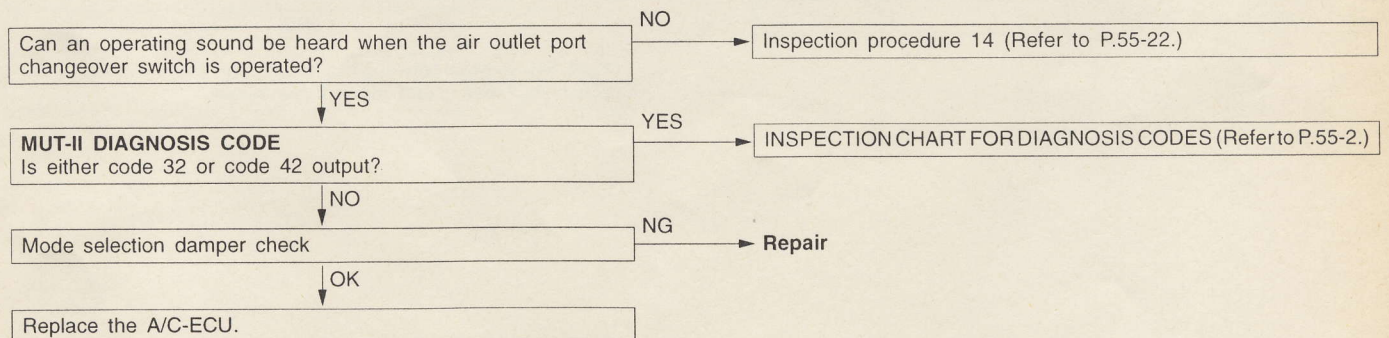

Inspection procedure 10

Inside/outside air selection is not possible.	Probable cause
If inside/outside air selection is not possible even when the inside/outside air changeover switch is on, the cause is probably a malfunction of the air selection damper motor.	<ul style="list-style-type: none"> • Malfunction of air selection damper motor • Malfunction of air selection damper • Malfunction of connector or harness • Malfunction of A/C-ECU

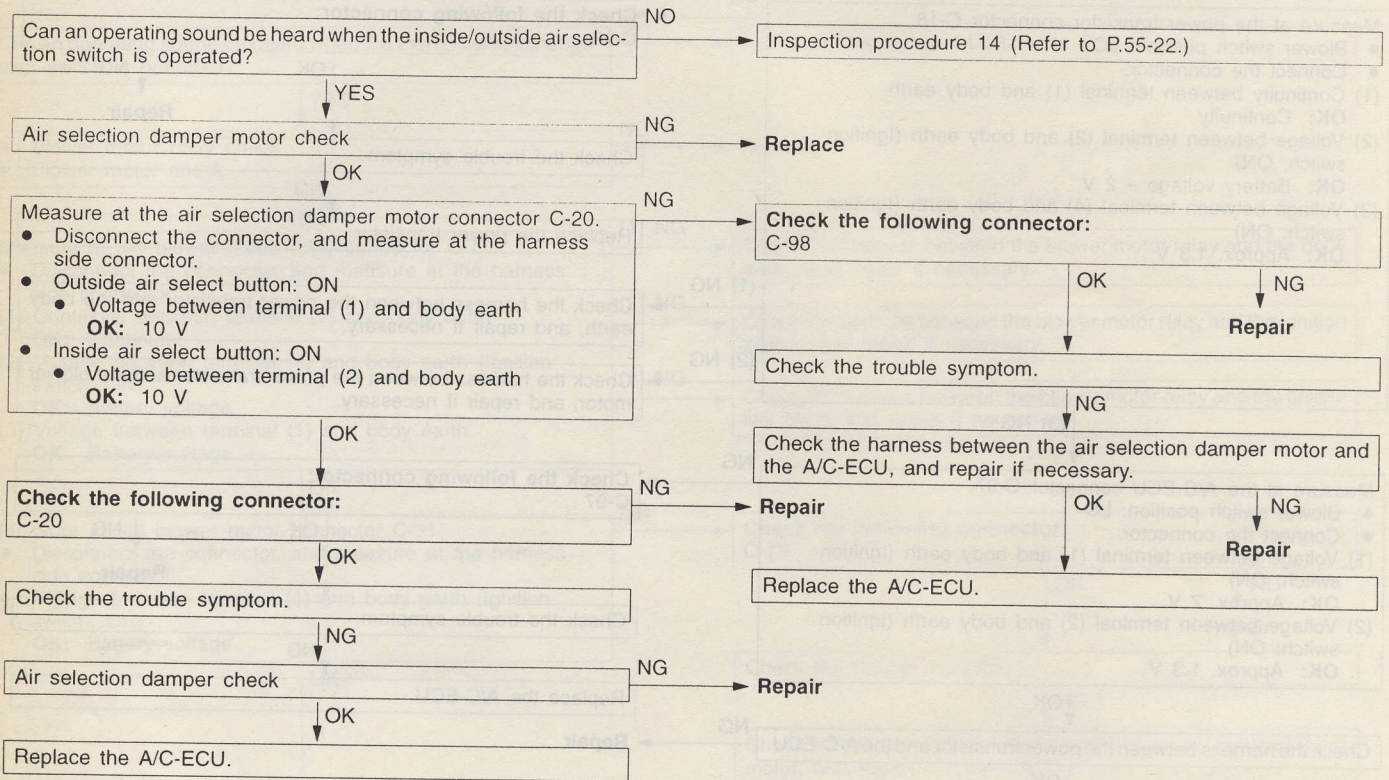

Probable cause	Inspection procedure 9
<ul style="list-style-type: none"> • Malfunction of mode selection damper potentiometer • Malfunction of mode selection damper motor • Malfunction of mode selection damper • Malfunction of connector or harness • Malfunction of A/C-ECU 	<p>The cause is probably a malfunction of the air outlet port changeover signal input system or output system. The MUTI can be used to check the diagnosis code in order to check the cause of the problem for each separate system.</p> <p>Is either code 32 or code 43 output?</p> <p>NO</p> <p>Check selection damper check</p> <p>OK</p> <p>Replace the A/C-ECU</p>

Inspection procedure 11

Defroster function does not operate.	Probable cause
If the defroster function does not operate when the defroster switch is turned on, the cause is probably a malfunction of the A/C or of the air outlet port changeover circuit.	<ul style="list-style-type: none"> • Malfunction of air conditioner drive system • Malfunction of mode selection damper drive system • Malfunction of connector or harness • Malfunction of A/C-ECU

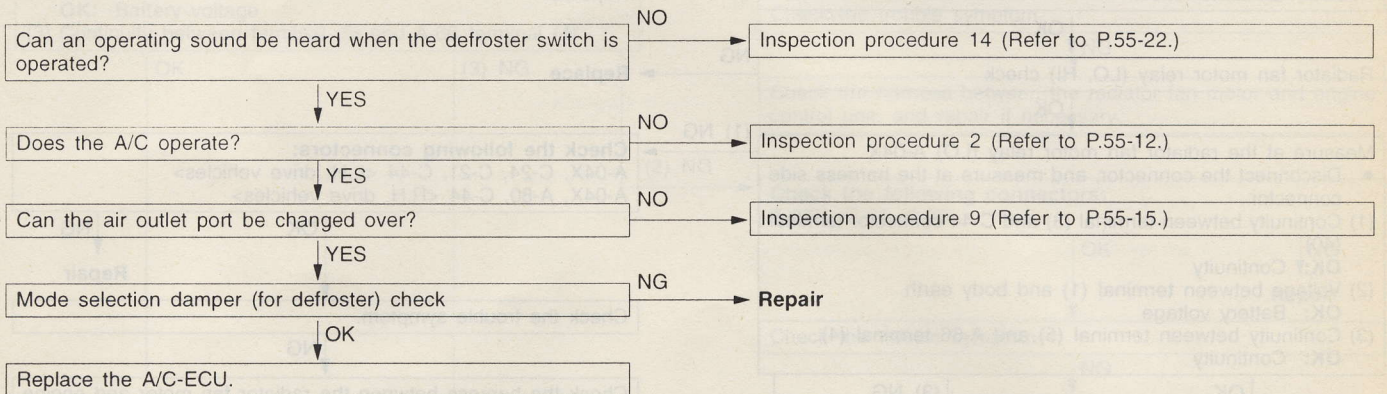

Inspection procedure 12

Radiator fan motor does not operate.	Probable cause
If the radiator fan does not operate even though the air conditioner is operating, the cause is probably a malfunction of the radiator fan motor operating circuit. In such a case, the cooling performance will drop when the vehicle is not moving.	<ul style="list-style-type: none"> • Malfunction of radiator fan motor • Malfunction of radiator fan motor relay (LO, HI) • Malfunction of connector or harness

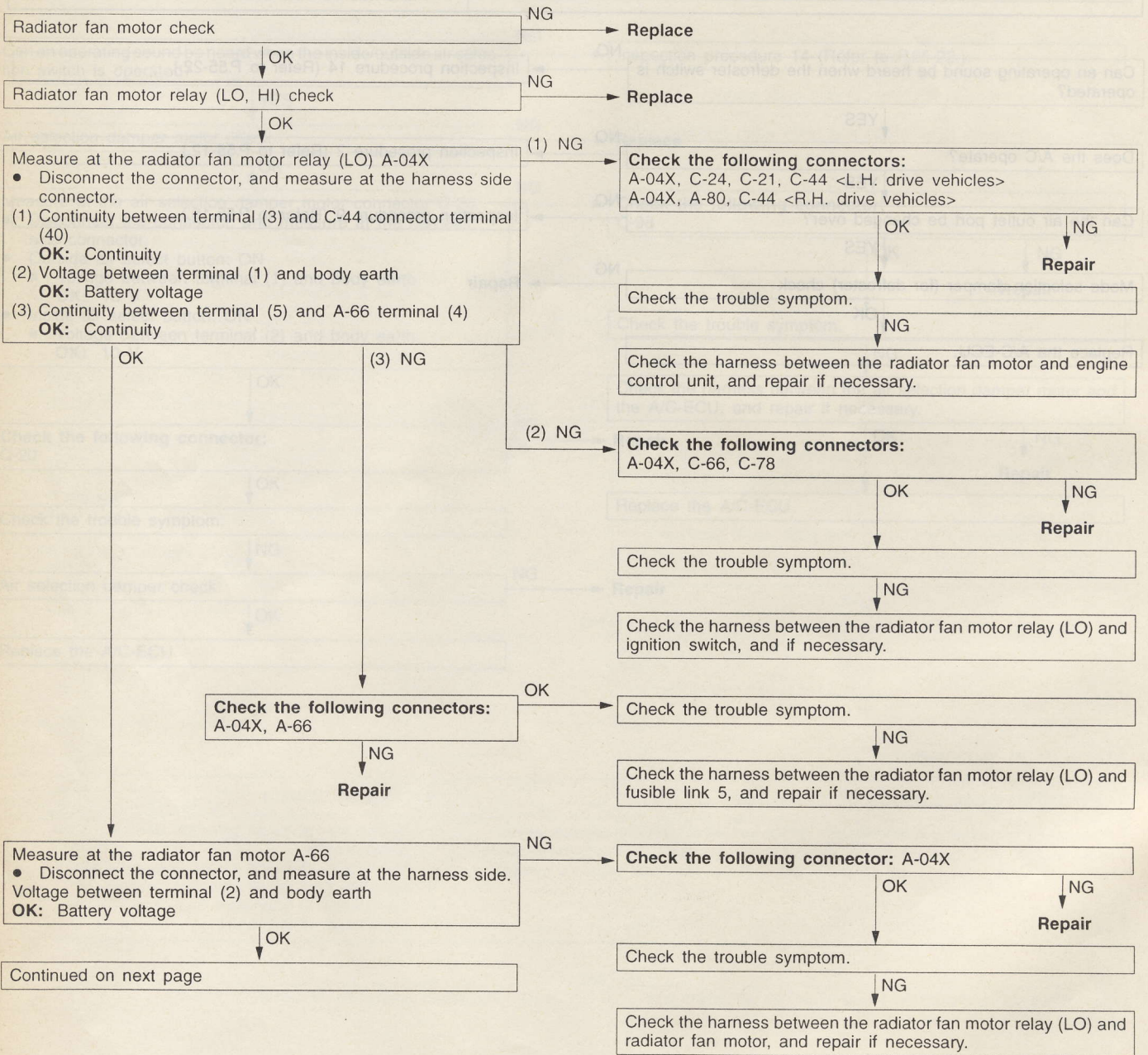

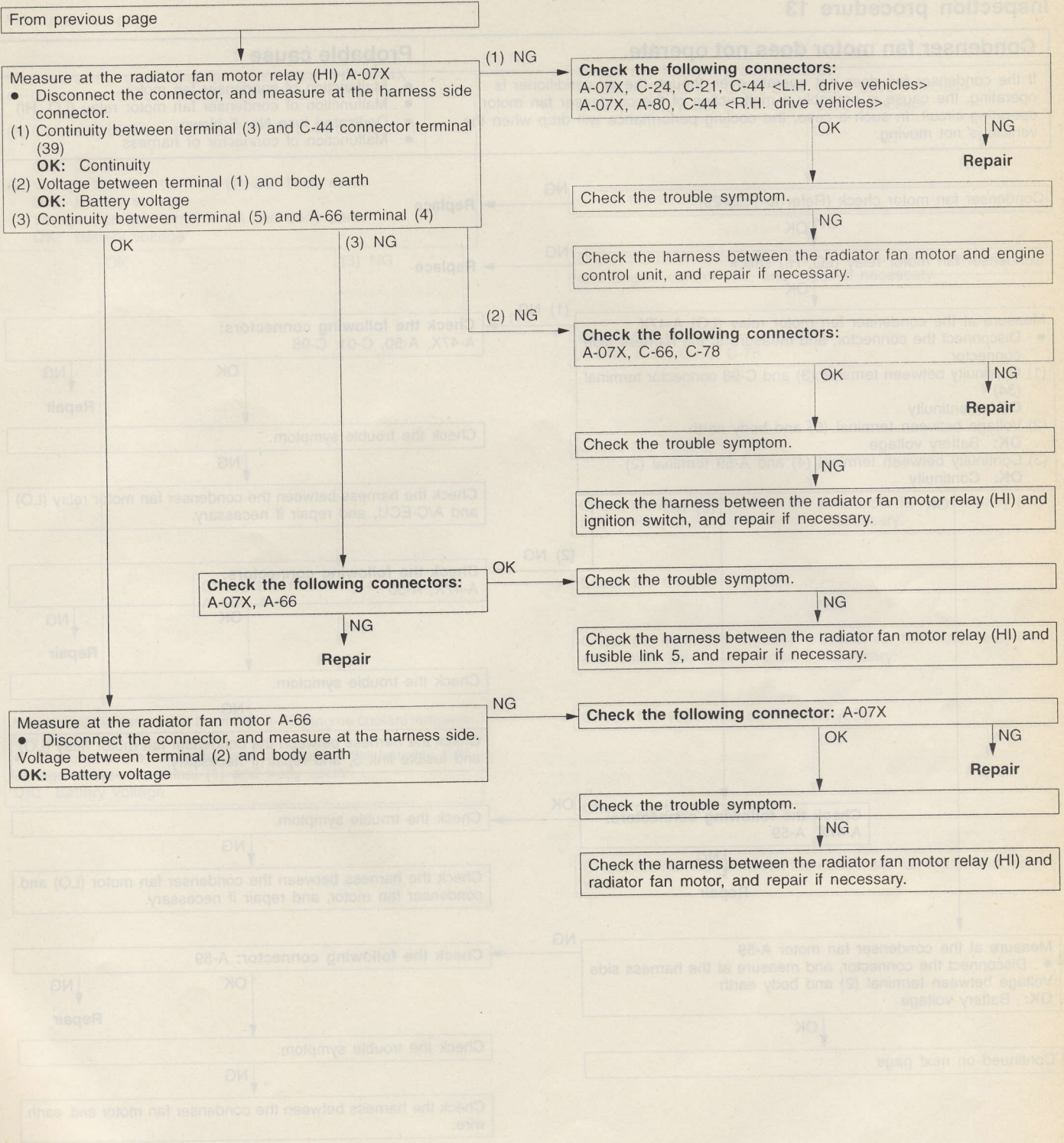

Inspection procedure 13

Condenser fan motor does not operate.	Probable cause
If the condenser fan does not operate even though the air conditioner is operating, the cause is probably a malfunction of the condenser fan motor operating circuit. In such a case, the cooling performance will drop when the vehicle is not moving.	<ul style="list-style-type: none"> • Malfunction of condenser fan motor • Malfunction of condenser fan motor relay (LO, HI) • Dedicated fuse No. 5 blown • Malfunction of connector or harness

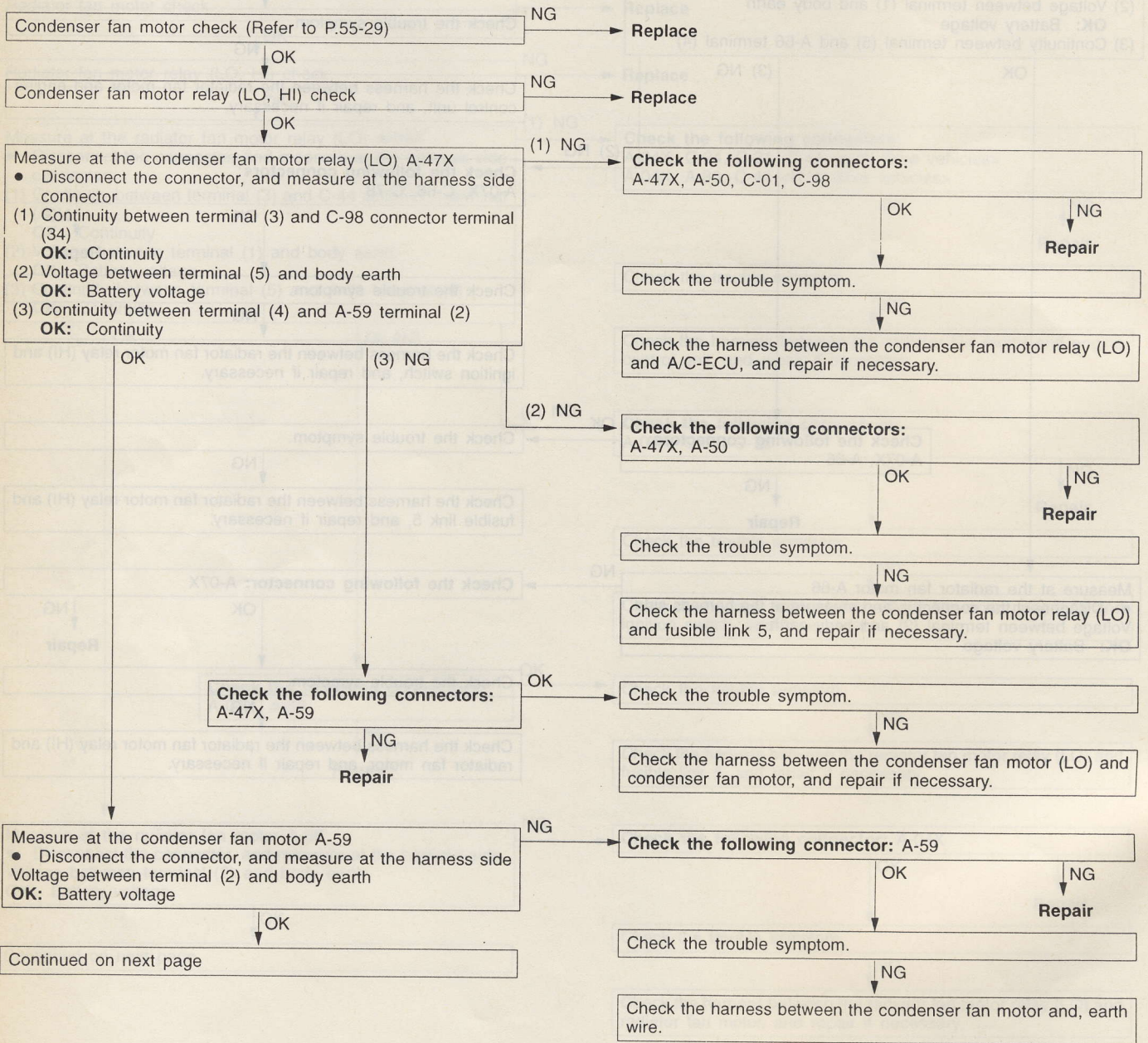

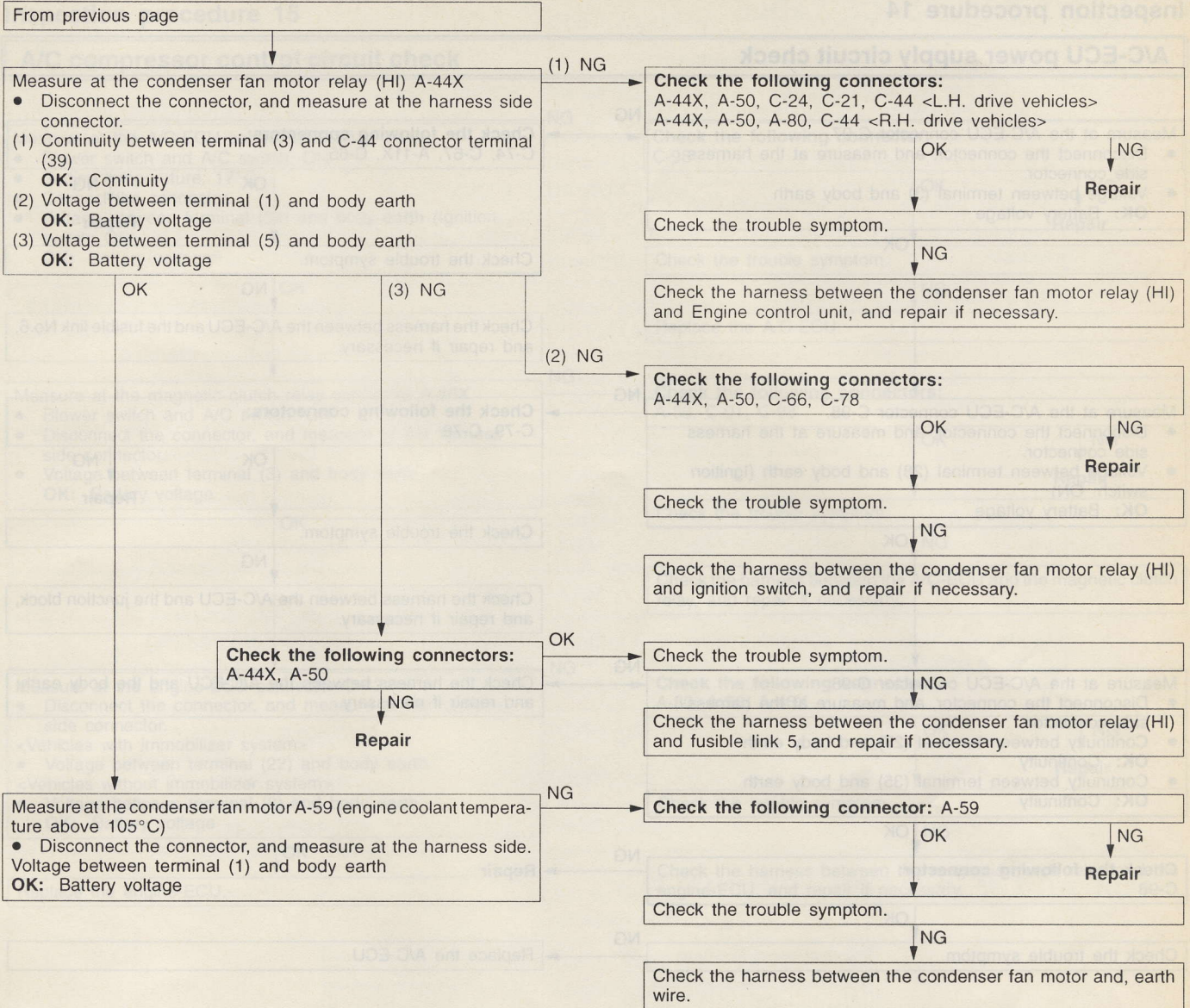

Inspection procedure 14

A/C-ECU power supply circuit check

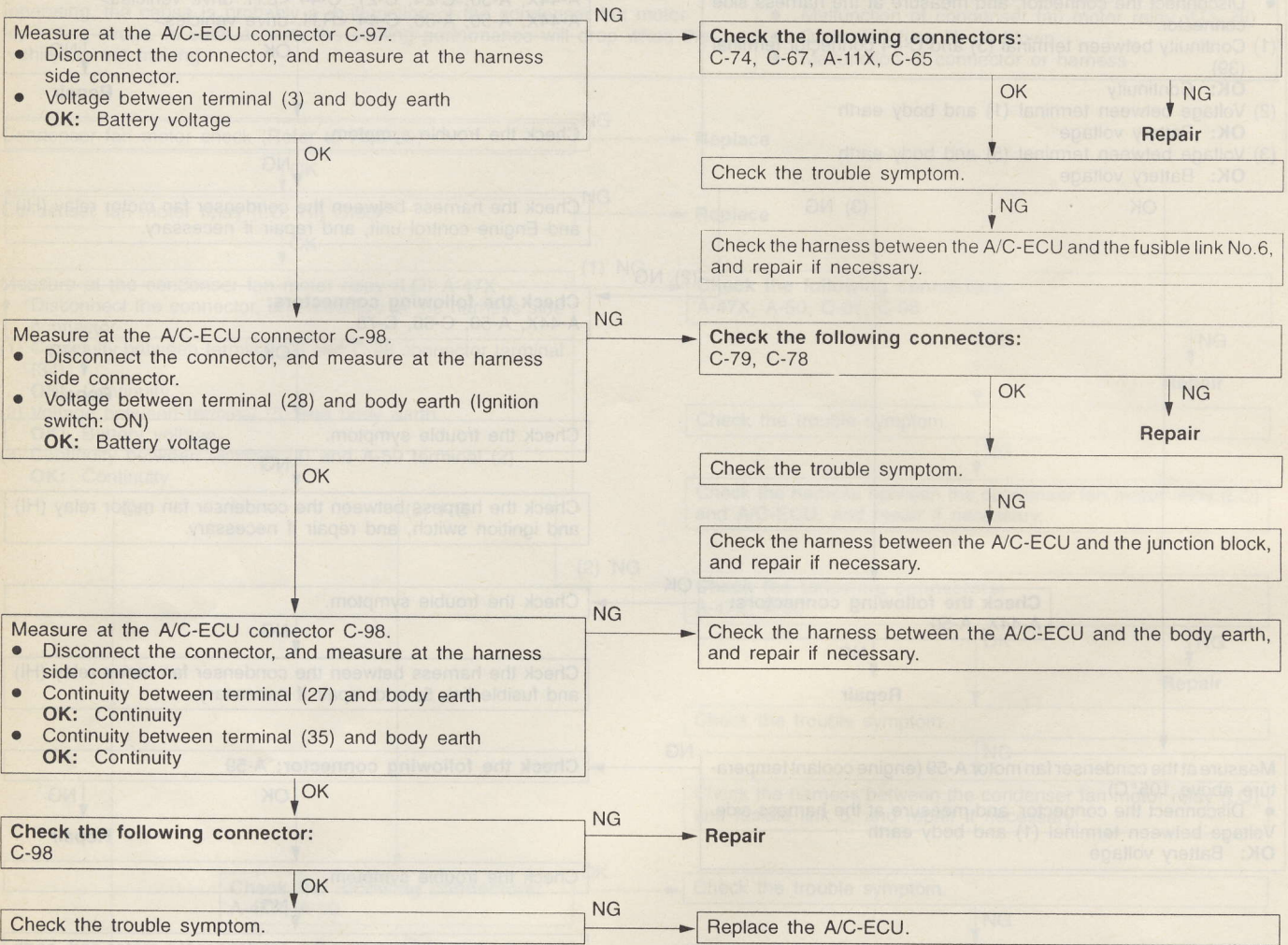

Inspection procedure 15

A/C compressor control circuit check

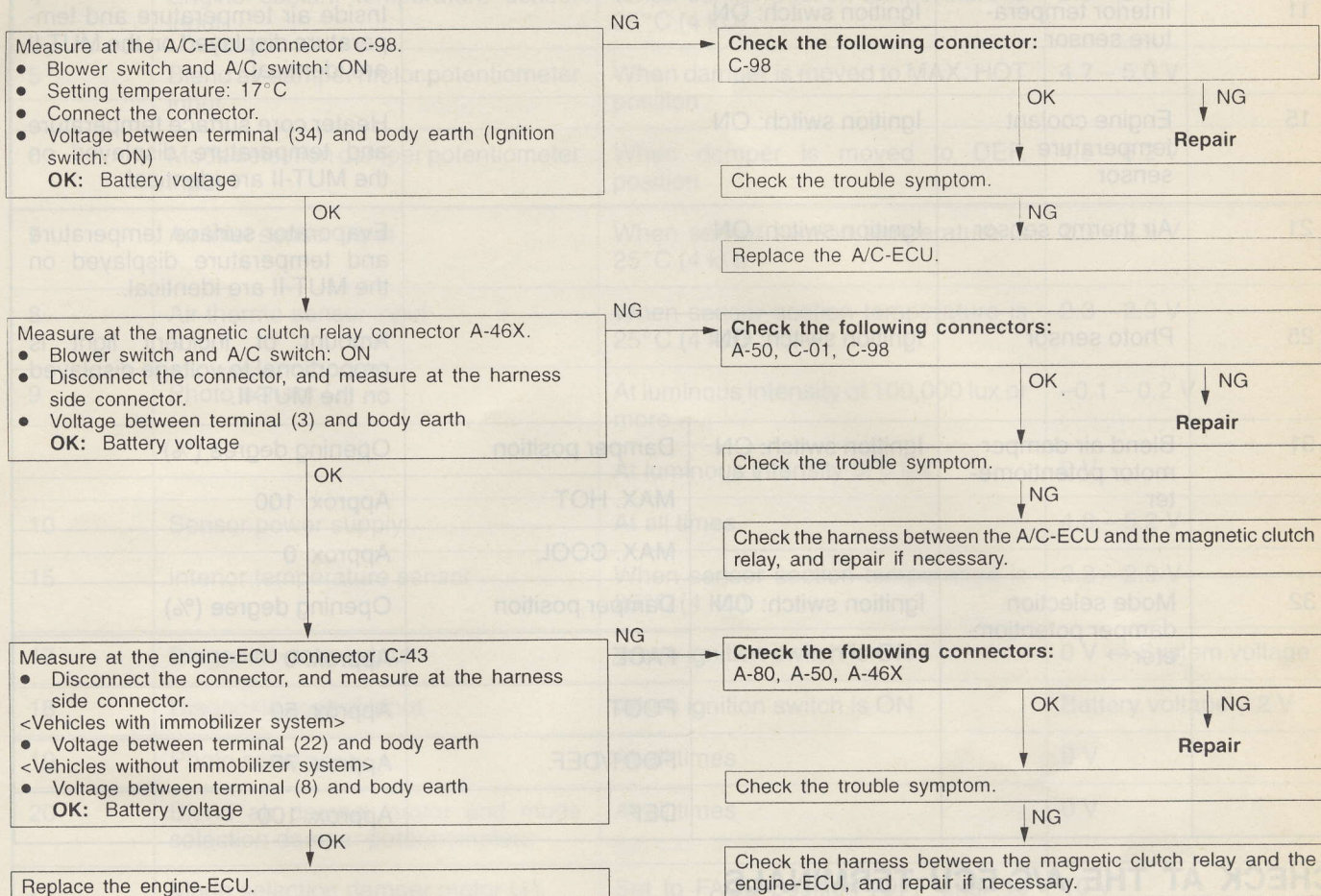

Terminal No.	Check item	Check condition	Normal condition
1	Air conditioner power transistor collector	When blower switch is at LO	System voltage
2	Air conditioning power transistor base	When blower switch is at OFF	Approx. 0 V
3	Air conditioning power transistor emitter	When blower switch is at HI	Approx. 1.3 V
4	A/C-ECU backup power supply	At all times	System voltage

55-24 HEATER, AIR CONDITIONER AND VENTILATION – Troubleshooting

DATA LIST REFERENCE TABLE

Item No.	Check item	Check condition	Normal condition	
11	Interior temperature sensor	Ignition switch: ON	Inside air temperature and temperature displayed on the MUT-II are identical.	
15	Engine coolant temperature sensor	Ignition switch: ON	Heater core surface temperature and temperature displayed on the MUT-II are identical.	
21	Air thermo sensor	Ignition switch: ON	Evaporator surface temperature and temperature displayed on the MUT-II are identical.	
25	Photo sensor	Ignition switch: ON	Amount of incident light is proportional to voltage displayed on the MUT-II.	
31	Blend air damper motor potentiometer	Ignition switch: ON	Damper position	Opening degree (%)
			MAX. HOT	Approx. 100
			MAX. COOL	Approx. 0
32	Mode selection damper potentiometer	Ignition switch: ON	Damper position	Opening degree (%)
			FACE	Approx. 0
			FOOT	Approx. 50
			FOOT/DEF.	Approx. 75
			DEF.	Approx. 100

CHECK AT THE A/C-ECU TERMINALS

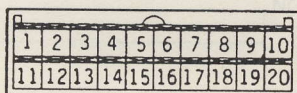

20P0031

20P0030
00006895

Terminal No.	Check item	Check condition	Normal condition
1	Air conditioner power transistor collector	When blower switch is at OFF	System voltage
		When blower switch is at LO	Approx. 9 V
		When blower switch is at HI	Almost no voltage (0 V)
2	Air conditioning power transistor base	When blower switch is at OFF	0 V
		When blower switch is at LO	Approx. 1.3 V
		When blower switch is at HI	Approx. 2.5 V
3	A/C-ECU backup power supply	At all times	System voltage

Terminal No.	Check item	Check condition	Normal condition
4	Engine coolant temperature sensor input	When sensor section temperature is 25°C (4 kΩ)	2.3 – 2.9 V
5	Blend air damper motor potentiometer input	When damper is moved to MAX. HOT position	4.7 – 5.0 V
6	Mode selection damper potentiometer input	When damper is moved to DEF. position	4.8 – 5.2 V
7	Air inlet sensor input	When sensor section temperature is 25°C (4 kΩ)	2.3 – 2.9 V
8	Air thermo sensor input	When sensor section temperature is 25°C (4 kΩ)	2.3 – 2.9 V
9	Photo sensor (-)	At luminous intensity of 100,000 lux or more	-0.1 – 0.2 V
		At luminous intensity of 0 lux	0 V
10	Sensor power supply	At all times	4.8 – 5.2 V
15	Interior temperature sensor	When sensor section temperature is 25°C (4 kΩ)	2.3 – 2.9 V
17	Diagnosis date output	When ignition switch is ON	0 V ↔ System voltage
18	Diagnosis control input	When ignition switch is ON	Battery voltage – 2 V
19	Photo sensor (+)	At all times	0 V
20	Blend air damper motor and mode selection damper potentiometers	At all times	0 V
21	Mode selection damper motor (+)	Set to FACE position (OFF after 40 seconds of output)	10 V
		Set to DEF. position (OFF after 40 seconds of output)	0.5 V
22	Blend air damper motor (-)	Set the setting temperature to 17°C and set to MAX. COOL position (OFF after 40 seconds of output)	10 V
		Set the setting temperature to 32°C and set to MAX. HOT position (OFF after 40 seconds of output)	0.5 V
23	Air selection damper motor (-)	Set to inside air position (OFF after 40 seconds of output)	0.5 V
		Set to outside air position (OFF after 40 seconds of output)	10 V
24	Mode selection damper motor (-)	Set to FACE position (OFF after 40 seconds of output)	0.5 V
		Set to DEF. position (OFF after 40 seconds of output)	10 V

55-26 HEATER, AIR CONDITIONER AND VENTILATION – Troubleshooting

Terminal No.	Check item	Check condition	Normal condition
25	Blend air damper motor (+)	Set the setting temperature to 17°C and set to MAX. COOL position (OFF after 40 seconds of output)	0.5 V
		Set the setting temperature to 32°C and set to MAX. HOT position (OFF after 40 seconds of output)	10 V
26	Air selection damper motor (+)	Set to inside air position (OFF after 40 seconds of output)	10 V
		Set to outside air position (OFF after 40 seconds of output)	0.5 V
27	Earth	At all times	Continuity
28	A/C-ECU power supply	When ignition switch is ON	System voltage
29	ILL earth (rheostat)	At all times	Continuity
30	ILL power supply	When lighting switch is at ON	System voltage
33	Engine-ECU output	When air mix damper is at MAX. COOL position	0 V
		When air mix damper is at MAX. HOT position	System voltage
34	A/C output	When A/C is OFF	0 V
		When A/C is ON	System voltage
35	Earth	At all times	Continuity

AIR CONDITIONER CONTROL PANEL AND ECU ASSEMBLY

REMOVAL AND INSTALLATION

Pre-removal and Post-installation Operation

- Floor Console Removal and Installation

CAUTION: SRS

When installing or removing the floor console, don't allow any impact or shock to the SRS-ECU.

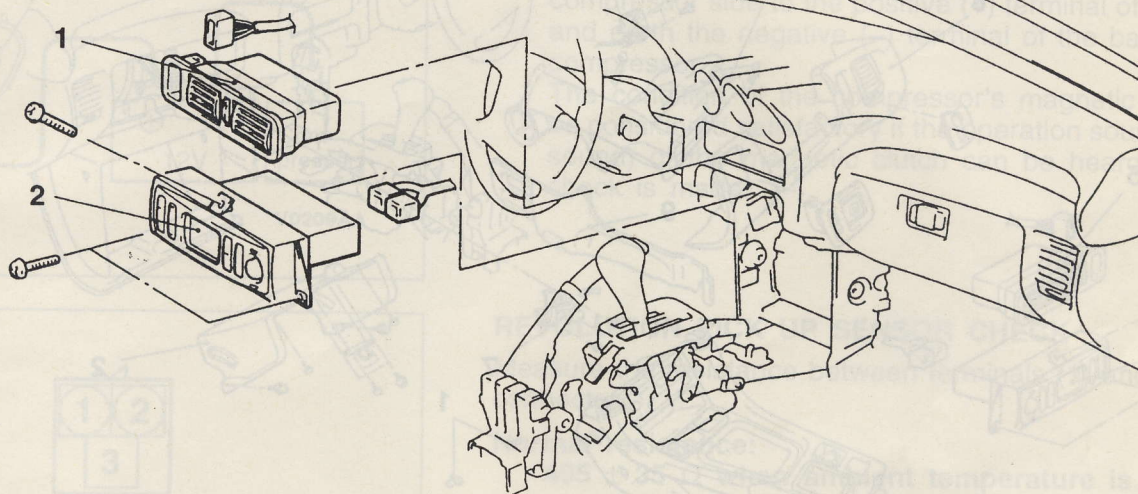

A20F0185

Removal steps



1. Center air outlet assembly
2. Air conditioning control panel and ECU assembly

NOTE

For service point, refer to Basic Manual.

DAMPER CONTROL MOTOR ASSEMBLY**REMOVAL AND INSTALLATION****CAUTION: SRS**

When installing or removing the floor console, don't allow any impact or shock to the SRS-ECU.

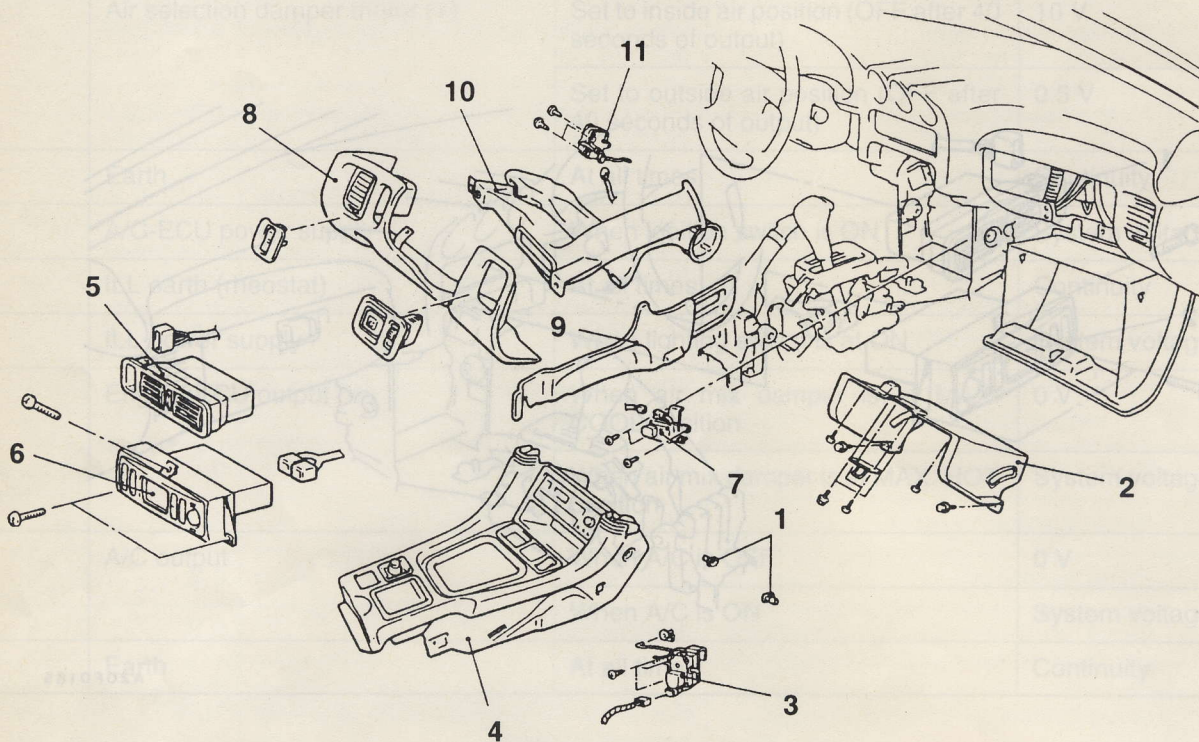

A20F0184

Air selection damper motor assembly removal steps

1. Stopper
2. Glove box outer case
3. Air selection damper motor assembly

Blend air damper motor assembly removal steps

4. Floor console

NOTE

For service point, refer to Basic Manual.



5. Center outlet assembly
6. Air conditioning control panel and ECU assembly
7. Blend air damper motor assembly

Mode selection damper motor assembly removal steps

8. Knee protector
9. Side console cover
10. Shower duct and lap cooler duct
11. Mode selection damper motor assembly

INSPECTION

Refer to Basic Manual.

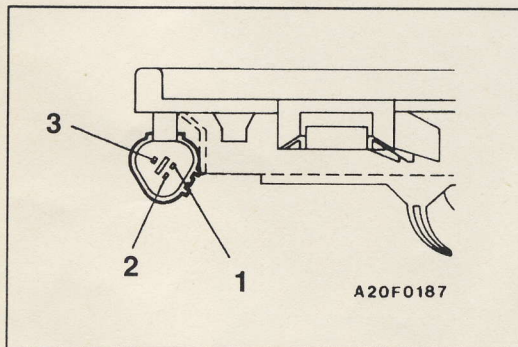
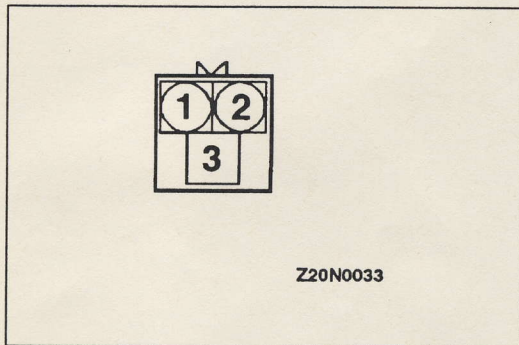
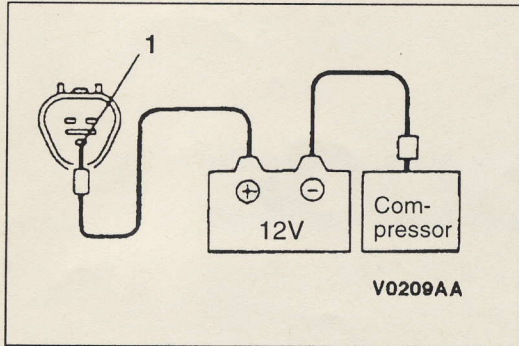
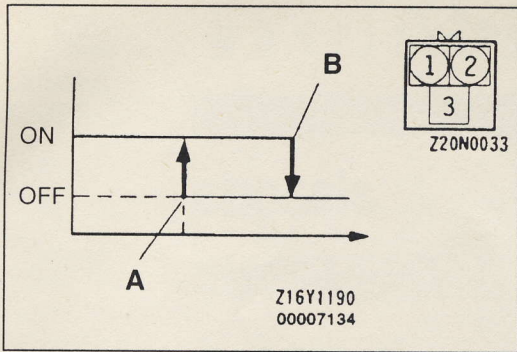

COMPRESSOR

INSPECTION

THERMOSTAT CHECK AND COMPRESSOR'S MAGNETIC CLUTCH OPERATION CHECK

- (1) Dip the thermostat in engine oil.
- (2) Check for continuity across terminals (3) and compressor body earth when the engine oil is heated:

Standard value:

Continuity at approx. 110°C or less at A point
No continuity at approx. 155°C or more at B point

- (3) While the thermostat is on, connect terminal (1) at the compressor side to the positive (+) terminal of the battery and earth the negative (-) terminal of the battery to the compressor.

The condition of the compressor's magnetic clutch can be considered satisfactory if the operation sound (a "click" sound) of the magnetic clutch can be heard when this check is made.

REVOLUTION PICK UP SENSOR CHECK

Measure the resistance between terminals (1) and (2) of the connector.

Normal resistance:

405 ± 35 Ω when ambient temperature is 20°C

If the measurement deviates greatly from the above resistance, replace the revolution pick up sensor assembly.

CONDENSER AND CONDENSER FAN MOTOR

INSPECTION

CONDENSER FAN MOTOR CHECK

- (1) Apply battery voltage (+) to terminal (1) and ground (-) terminal (3); at this time, check that the condenser fan motor turns.
- (2) Apply battery voltage (+) to terminal (2) and ground (-) terminal (3); at this time, check that the condenser fan motor turns.

Pub. No. PWUE9119-G

Pub. No. PWUE9203-5

ENGLISH

EUROPE AND EXPORT

 **MITSUBISHI MOTORS CORPORATION**

Jun. 1997 Printed in Japan